

INDICE CATALOGO 2008

MARCA	Página
PORTAESCOBILLAS	1
ESCOBILLAS BOSCH	11
ESCOBILLAS C.A.V.	23
ESCOBILLAS DELCO-REMY	23
ESCOBILLAS DENSO	26
ESCOBILLAS FIAT	29
ESCOBILLAS FIAT DENSO	33
ESCOBILLAS FORD	34
ESCOBILLAS HITACHI	35
ESCOBILLAS ISKRA	39
ESCOBILLAS LUCAS	40
ESCOBILLAS MARELLI	43
ESCOBILLAS MITSUSISHI	44
ESCOBILLAS MITSUBA	47
ESCOBILLAS PAL MAGNETON	47
ESCOBILLAS VALEO - DUCELLIER	48
ESCOBILLAS VALEO - PARIS-RHONE	50
ESCOBILLAS VALEO MOTOROLA - PARIS-RHONE	55
ESCOBILLAS AUXILIARES	56
ESCOBILLAS PARA MOTORES DE CALEFACCION	57
INSTRUCCIONES DE MONTAJE	58
EQUIVALENCIAS - CRUCES DE REFERENCIAS	59

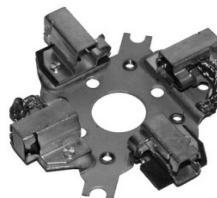

7 7114 1
7 7117 1
7 7118 1



7 7115 1
7 7119 1
7 7120 1



7 7314 1, 7 7317 1, 7 7318 1

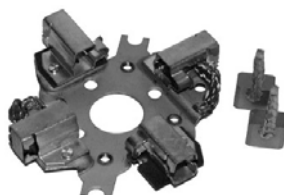

7 7315 1

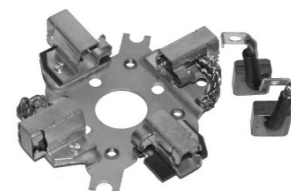
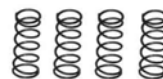

7 7316 1, 7 7319 1, 7 7320 1

BÜRSTENHALTER / BRUSH-HOLDERS

BOSCH

EF, GF, JE, JF

IKA-No.	Bosch-Ref.	Unit-No.
7 7114 1	1 001 329 900 1 004 336 025,028,029,055 with 2 negative brushes and 4 springs EB(L) 12V 08./0.95 kW EB(R) 12V 0.7/0.8/0.95 kW EF(L) 12V 0.7/0.8/0.95 kW EF(R) 12V 0.8/0.85 kW	0 001 208 200-202,204,216-218, 224,229,233,403,404, 411,412,416,419, 425-429 211 200-208,210,215, 218-225,233-236,239 242-249,251,253,254, 257,258,992,993,997 212 199,202-214,400-403
7 7314 1	1 004 336 055 with additional positive brushes 2 x BS 75 -----	
7 7115 1	2 004 336 027 / 041 with 2 negative brushes and 4 springs IF/JF(L) 12V 1.9/2.4 kW IF/JF(R) 12V 1.9-21.7kW	0 001 362 034-043,045-053,057- 064,069-079,081,083- 086,088-097,100,102- 105,300-314,316-319, 321-332,600-607,700- 705 366 001-006,008-022,024- 029 9 000 143 203,204,408,411,413, 414,420
7 7315 1	2 004 336 027, 041 with additional positive brushes 2 x BS 139	
7 7316 1	2 004 336 02, 041 with additional positive brushes 2 x BS 143 -----	
7 7117 1	1 004 336 009,033,036, 040,046,057 with 2 negative brushes and 4 springs	0 001 208 006, 007 214 002 215 001 311 024,030,031,047,050- 052,054-056,100,103, 107,108,110,111,113, 115,120,123,124,126, 130,138,139,146,147, 149 312 101-111 313 006 314 005,006,009-015,017, 018,024-029,032,034, 036-038,042,043,045- 047,049 315 005
	EF(L/R) 12V 0.8 kW GB(L/R) 12V 1.5 kW GF(L) 12V 1.0-1.5 kW GF(R) 12V 1.0-1.6 kW	

IKA-No.	Bosch-Ref.	Unit-No.
7 7317 1	1 004 336 046 with additional positive brushes 2 x BS 104 -----	
7 7118 1	1 004 336 027 with 2 negative brushes and 4 springs EF(L/R) 6V 0.5 kW	0 001 207 003,005,009,015,018
7 7318 1	1 004 336 027 with additional positive brushes 2 x BS 49 -----	
7 7119 1	2 004 336 028,044,067 with 2 negative brushes and 4 springs IF/JF(R) 12V 3.0/3.1 kW	0 001 367 001-018,020-025,027- 032,034-039,041-048, 050-052,054-059,061- 068,070-072,074-079, 081-082,300-303 369 001-006,012, 013-018, 020-024 9 000 143 410,412,415,416,419
7 7319 1	2 004 336 028,044,067 with additional positive brushes 2 x BS 164 -----	
7 7120 1	2 004 336 031 with 2 negative brushes and 4 springs IF/JF(R) 24V 4.0 kW	0 001 368 001,002,004-007,009, 010,012-014,016,018- 022,024,027-031,034- 041,047,049,050,052, 055-060,062,063,068- 073,076,077,079,081, 082,085,086,088,300, 301,305-307,309-313, 315-317,319-321 9 000 143 600-604
7 7320 1	2 004 336 031 with additional positive brushes 2 x BS 145 -----	



7 7121 1
7 7122 1



7 7137 1
7 7200 1

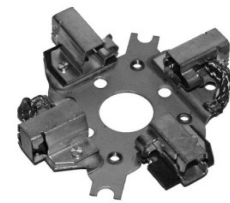

7 7138 1



7 7136 1
7 7139 1
7 7201 1

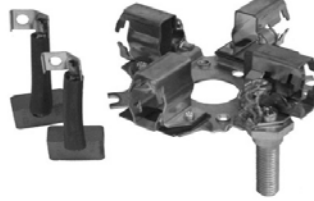

7 7337 1
7 7400 1

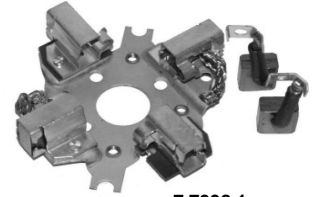
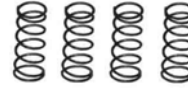



7 7338 1

BÜRSTENHALTER / BRUSH-HOLDERS

BOSCH

JD, JE, JF

IKA-No.	Bosch-Ref.	Unit-No.
7 7121 1	1 004 336 900 with 4 brushes and 4 springs GF(L/R) 12V 1.7 kW -----	0 001 312 108,109 317 007-013,016-019 022-025
7 7122 1	1 004 336 901 with 4 brushes and 4 springs EF(R) 12V 0.95 kW -----	0 001 208 702,706,707,709-715, 717-719 9 000 333 106,114,117
7 7136 1	2 004 336 078 with 4 brushes and 4 springs JE(R) 24V 6.7 kW -----	0 001 371 004,006,008,010,013, 016,018-020
7 7137 1	2 004 336 085,087 with 2 negative brushes and 4 springs IE/JE(R) 24V 6.2 kW	0 001 372 001,004
7 7337 1	2 004 336 085,087 with additional positive brushes 2 x BS 171 -----	
7 7138 1	2 004 336 066,086 with 2 negative brushes and 4 springs ID(R) 24V 4.8 kW IF(R) 24V 5.2 kW IE(R) 24V 6.2 kW	0 001 364 300,301,400,402 372 002,003,005-008

IKA-No.	Bosch-Ref.	Unit-No.
7 7338 1	2 004 336 066,086 with additional positive brushes 2 x BS 171 -----	
7 7139 1	2 004 336 077 with 4 brushes and 4 springs brush-holder insulated IE(R) 24V 6.7 kW -----	0 001 371 005,007,009,012 014,017
7 7200 1	2 004 336 077  with 2 negative brushes IE(R) 24V 4.0 kW	0 001 368 083
7 7400 1	2 004 336 064  with additional positive brushes 2 x BS 199	
7 7201 1	2 004 336 079  with 4 brushes and 4 springs IE(R) 12V 5.0 kW	0 001 370 003,004

All Brush-Holders are supplied with 4 springs

For single springs, screws or spring-kits see chapter SMALL PARTS



7 7123 1



7 7124 1



7 7125 1



7 7126 1



7 7127 1
7 7128 1



7 7129 1

BÜRSTENHALTER / BRUSH-HOLDERS

BOSCH - GEAR STARTER

IKA-No.	Bosch-Ref.	Unit-No.
7 7123 1	1 004 336 822,838,854 856,861 DM(R/L) 12V 0,7kW clockwise and anticlock (mono brushes)	0 001 116 003-006,008,009

7 7124 1	1 004 336 806,812,816, 823,832,859, 902,903,907, 912,913,918, 921,922,934, 935,936,941, 950,954,960, 965,968,971, 973,974,986, 995,998 DW(R) 12V 1.1-1.4 kW DW(R) 24V 1.6 kW clockwise	0 001 108 001-004,009-013, 016-020,022-033, 035,037-040,042-049, 051-058,061-066, 068-075,078-093,098, 100-126,128-141, 143-146,148-160, 162,166,167,169-178, 181,183,184,188-190, 196,197,199,995-999

7 7125 1	1 004 336 815,817,834 843,844,846, 865,915,916, 917,928,939, 940,943,952, 953,963,967, 969,992,993, DA(L) 12V 0.9 kW anticlock DM(L/R) 12V 0.8-1.0 kW clockwise and anticlock	0 001 112 003-029,032-039, 041,044,045 113 001-015,017 114 003-006,008-010, 014-017,020-022 133 003,004

7 7126 1	1 004 336 820,821,937 951,987 DB/DW(L) 12V 1.1 kW anticlock	0 001 106 001,002,004,016 107 003-008,011,020-024, 039,040,046,052,053, 058,080,090 121 006-011,016-019,022, 023

IKA-No.	Bosch-Ref	Unit-No.
7 7127 1	1 004 336 800,808,839, 847,858,906, 926,927,933, 945,948,958, 983,988,990, 991 DB/DW(L) 12V 1.7-2.0 kW anticlock	0 001 109 011,012,023,029, 044,047 110 001,002,009,010,014, 015,018,031-033,047, 057-062,069,070,073, 076,077,080,081, 084-087,098,099,118, 119 124 004 125 001-013,016-019, 021,022,505,506

7 7128 1	1 004 336 811,904,911, 919,923,944, 961 DW(L) 12V 1.1-1.4 kW DW(L) 24V 1.6 kW anticlock	0 001 108 005,014,015,021, 050,058-060,076,077, 094-097,099,123,127, 147,168 111 001,005

7 7129 1	1 004 336 803,804,807 819,826,840, 852,909,914, 924,925,931, 942,947,955, 956,959,962, 976,981,984, 996,997 DB/DW(R) 12V 1.7-2.0 kW clockwise -flex 86 mm	0 001 109 001-003,006-009, 014,017,018,021,022, 025,026,028,030,031, 033,036,040,043,045, 048,049,057,058 110 004,005,007,008, 011-013,016,017,019, 022-025,027-030, 039-046,048,049, 051-056,063-068,071, 072,075,078,079,082, 088-092, 100-102,104-108, 110-113,115,120, 122-127,999 115 002,007 123 001 124 015 125 501-504,507,508 F 010 ALO 101



7 7130 1
7 7133 1



7 7131 1



7 7132 1



7 7134 1



7 7199 1



7 7135 1



7 7202 1, 7 7206 1
7 7207 1



7 7203 1









7 7204 1, 7 7205 1

BÜRSTENHALTER / BRUSH-HOLDERS

BOSCH - GEAR STARTER

IKA-No.	Bosch-Ref.	Unit-No.
7 7130 1	9 003 334 314 1 004 112 906,907 * 9 003 334 165,171,175 *	0 001 218 003-031,100-115 118,120-131,133-147 150-168,171-178
	* with field coil EV(R) 12V 2.2 kW clockwise	
7 7131 1	1 004 336 801,809,810 813,814,827, 828,831,833, 842,853,938, 957,964,970, 975,980,985, 989	0 001 106 007-012,014,015, 017-019 107 009,010,012-019, 025-034,037,038,041, 043-045,047-049, 054-056,059-069, 072,075-077,079, 082,083,085,087-089, 091-098,100,101
	DB/DW(R) 12V 1.1 kW clockwise	121 001-003
7 7132 1	1 004 336 802,835,908 946,949,994	0 001 110 003,026,095,114
	DW(R) 12V 1.7 kW clockwise - flex 105 mm	
7 7133 1	9 003 334 341 9 003 334 155,156,158 *	0 001 218 116,117,119,132,148, 149,170
	* with field coil EV (L) 12V 2.2 kW anticlock	
7 7134 1	1 004 336 702,703,718, 866	0 001 107 401-411,415,417,418, 423-426,429,431,432
	DW (R) 12V 1.1 kW clockwise R70-M10,15,20,25 12V(R)	
7 7135 1	1 004 336 884,885	0 001 110 086,087,118,119, 133,134 124 001-008,011-014, 022-025 125 003,004,011,035, 039,040,048,049
	DB(L)12V 1.8/2.0 kW anticlock RF78-L 12V(L) VW overload protection starter	

IKA-No.	Bosch-Ref.	Unit-No.
7 7199 1	6 033 AD4 026 6 033 AD0 130,156 380,471 9 003 334 363	0 001 231 002-007,009-012
	EV (R) 24V 4.0 kW clockwise	
7 7202 1	1 004 336 879	0 001 120 400-411
	DB(L) 12V 0.9 kW anticlock RF70-S25 12V(L)	
7 7203 1	1 004 336 750,878	0 001 125 007,008,031,032, 042,043,046,047, 051,052
	DB(L) 12V 1.8/2.0 kW anticlock RF78-M 12V(L)	
7 7204 1	1 004 336 756,893	0 001 125 511-514,517,518
	DB(R) 12V 2.0 kW clockwise RF78-S 12V(R)	
7 7205 1	1 004 336 708,886	0 001 108 400-406,408
	DW(R) 12V 1.4 kW clockwise RF70-L15,25 12V(R)	
7 7206 1	1 004 336 896	0 001 121 402,403,408-411
	RF70-M25 12V(L) anticlock	
7 7207 1	1 004 336 713	0 001 124 026,027
	RF78-L35 12V(L) anticlock A2 3L,VW Lupo 3L Start/Stop	



7 7168 1, 7 7178 1



7 7169 1



7 7175 1



7 7176 1

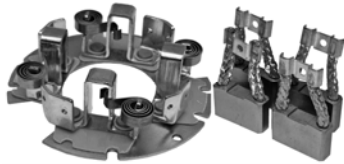

7 7368 1, 7 7468 1



7 7378 1, 7 7478 1

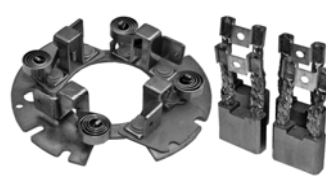



7 7375 1, 7 7475 1







7 7376 1, 7 7476 1

BRUSH-HOLDERS



DELCO



IKA-No.	OE-Ref.	Unit-No.
7 7168 1	1988121 1988439	42MT
	w/o. brushes	
7 7368 1	1988121	42MT
	w. brush set 4 x R 134	1852892 12V
7 7468 1	1988439	42MT
	w. brush set 4 x R 134 H	1852894 24V

7 7169 1	10475602	PG260M
	w. brushes 4 x 10499524 R 912 12V	9000786, 798, 804-806, 812, 819-822, 827, 834, 835, 844, 850, 851, 853

7 7175 1	10468705 10469238	37MT, 41MT series DD
	w/o. brushes	
7 7375 1	10468705	37MT, 41MT series DD
	w. brush set 4 x R 135	1852889 12V
7 7475 1	10469238	37MT, 41MT series DD
	w. brush set 4 x R 135 H	1852893 24V

7 7176 1	1979387 1979494	40MT 400, 450
	w/o. brushes	

IKA-No.	OE-Ref.	Unit-No.
7 7376 1	1979387	40MT
	w. brush set 4 x R 122	1852884 12V
7 7476 1	1979494	40MT
	w. brush set 4 x R 122 H	1852883 24V

7 7178 1	10456456	28MT
	w/o. brushes	
7 7378 1	10456456	28MT
	w. brushes 2 x 10456457 2 x 10456458	12V R 457 R 458
7 7478 1	10456456	28MT
	w. brushes 2 x 10457119 2 x 10457120	24V R 419 R 420

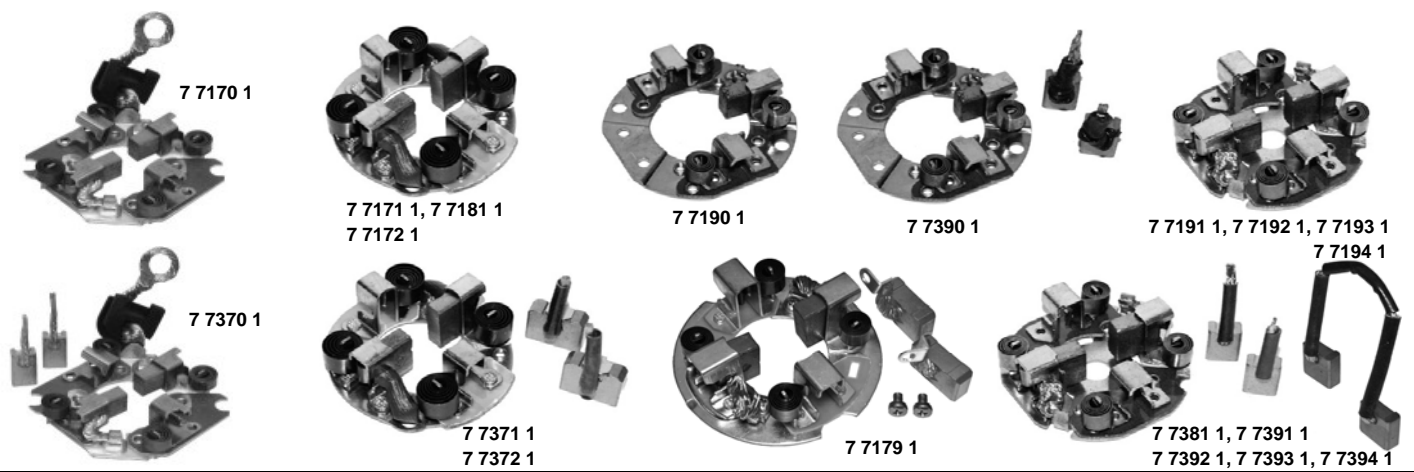

BRUSH-HOLDERS	DENSO	FIAT / MARELLI
---------------	-------	----------------

IKA-No.	OE-Ref.	Unit-No.
7 7170 1	028510-0560 (with 2 negative brushes)	028000-9490 Daihatsu
7 7370 1	028510-0560 with additional positive brushes 2 x JAS 85 -----	
7 7171 1	028510-0640 -0840 -5500 (with 2 negative brushes)	02800-7000, -7740, 7790, -8130, 9830 12800-0570, 0960, -1040
7 7371 1	028510-0640 with additional positive brushes 2 x JAS 77 -----	
7 7172 1	028510-0500 (with 2 negative brushes)	02800-5510,5860, -6290,6870, -7240,8070 12800-1790,3080
7 7372 1	028510-0500 with additional positive brushes 2 x JAS 88 -----	
7 7179 1	028510-0880 with 4 brushes 12/24V 3.0/5.5KW	128000-2450,2470, -3361,4250, -4682-4685 228000-331,332,573 -585,700
7 7181 1	028510-5190 (with 2 negative brushes)	128000-5210,5211,5680, -5682,6420,6422, -6720,6721,7400
7 7381 1	028510-5190 with additional positive brushes 2 x JAS 52	

IKA-No.	OE-Ref.	Unit-No.
7 7190 1	832 244 61 832 253 26	E80E 0,9-12 631 020 03,04,07,08 632 229 00,01 230 85 231 01,03,08 931 01 Palio, Tipo
	(with 1 negative brush)	
7 7390 1	832 244 61, 832 253 26 with additional positive brushes JS 39 + JS 40 -----	
7 7191 1	832 263 36	E95RL 2,2/2,6-12 631 140 08,10,14 Ducato
	(with 2 negative brushes)	
7 7391 1	832 263 36 with additional positive brush pair JS 54 -----	
7 7192 1	832 212 41	E80 0,8/1-12 632 228 31-33,36-38 230 31-34
	(with 2 negative brushes)	
7 7392 1	832 212 41 with additional positive brushes 2 x JS 36 -----	
7 7193 1	542 944 44 832 204 61	M70R 1,4/1,8-12 E70R 1,4-12 631 110 00,05,08 632 234 30-33,35,36 235 30-33 236 39 934 35
	(with 2 negative brushes)	
7 7393 1	832 204 61 with additional positive brushes 2 x JS 34 -----	
7 7194 1	832 258 86	E80E 632 230 39 233 04 930 39
7 7394 1	832 258 86 with additional positive brushes JS 45 + JS 57	



7 7195 1
7 7196 1



7 7197 1
7 7198 1



7 7211 1

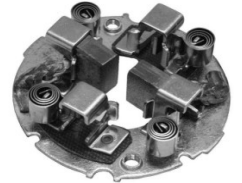

7 7213 1



7 7395 1, 7 7396 1



7 7397 1, 7 7398 1



7 7212 1



7 7313 1

BRUSH-HOLDERS

FIAT / MARELLI

FORD

IKA-No.	OE-Ref.	Unit-No.
7 7195 1	721 641 01	632 171 01,04-08,10,12,16-21,25, 26,38,47,48,54,56,58,63, 73,80,82,86,88,97 174 01-04,07,08,10,25,33,47
		MT71 / MT74 - 12 Volt
		(with 2 negative brushes)
7 7395 1	721 641 01 with additional positive brushes 2 x MAS 17	
7 7196 1	721 641 02	632 172 25,26
		MT72 - 24 Volt
		(with 2 negative brushes)
7 7396 1	721 641 02 with additional positive brushes 2 x MAS 19	
7 7197 1	721 647 01 723 627 01	632 168 02,08,11,14-18,25-27,31, 33,51,52,59,61,73,74,76, 84,96,98
		MT68 - 12 Volt
		(with 2 negative brushes)
7 7397 1	721 647 01 with additional positive brushes 2 x MAS 15	
7 7198 1	721 650 01	632 167 01-04,06-08,10,25-27,31, 33,38,40,41,47,48,63
		MT67 - -24 Volt
		(with 2 negative brushes)
7 7398 1	721 650 01 with additional positive brushes 2 x MAS 13	

IKA-No.	OE-Ref.	Unit-No.
7 7211 1	E90Z-11061-A,B,C (with 4 brushes) PMGR-Starter Ford USA	E90F-11000-AA,-BA E9SF-11000-AA,-BA F02F-11000-AA F07U-11000-AA,-BA FOCF-11000-AA,-BA FOOU-11000-AA F13U-11000-AA F17U-11000-AB F1VU-11000-AA
7 7212 1	F3RZ-11061-A (with 4 brushes) PMGR-Starter Ford Europe	93BB-11000-HB,-JB,-JC, -KA,-KB,-KC
7 7213 1	1C3U-11434-AA (with 2 brushes)	Ford USA PMGR-Starter 12V 3,6kW
7 7313 1	1C3U-11434-AA with additional positive brushes 2 x F 76	



7 7140 1



7 7141 1
7 7142 1



7 7143 1



7 7173 1



7 7341 1



7 7342 1



7 7343 1

BRUSH-HOLDERS

HITACHI

LUCAS

IKA-No.	OE-Ref.	Unit-No.
7 7140 1	2114-23106,53105, -63104,73105	Opel Astra D Opel Corsa D
	complete with positive brush-pair	S114-750,758,762,765,766A, 775A,800,801,804,805, 808,816,818,829A,B,850

7 7141 1	2114-4311 (with 2 negative brushes)	S114-252,252A,253A,254A 357A,374B,393, 480,481 Nissan 23378-05E00
7 7341 1	2114-4311 with additional positive brushes 2 x JAS 81	

7 7142 1	2130-1306 -13022 2240-3310 (with 2 negative brushes)	S13-62,62B,64,69,83,84,89A, 89B,92A,100,104,106B, 107A,114,121 Nissan 23378-10G00
7 7342 1	2130-1306 with additional positive brushes 2 x JAS 74	

7 7143 1	2250-7310 (with 2 negative brushes)	S13-45B S25-156 Nissan 23300-C8601 23300-J5500
7 7343 1	2250-7310 with additional positive brushes 2 x JAS 36	

IKA-No.	OE-Ref.	Unit-No.
7 7173 1	54268209 w/o. brushes	M35J 5M90,8M90,9M90
	 for brush sets	LASX 37-38-39 LASX 40-41



7 7184 1, 7 7185 1
7 7186 1



7 7187 1, 7 7188 1



7 7182 1, 7 7183 1
7 7189 1



7 7384 1, 7 7385 1
7 7386 1



7 7382 1, 7 7383 1
7 7389 1

BRUSH-HOLDERS MITSUBISHI

IKA-No.	OE-Ref.	Unit-No.
7 7182 1	M649T03571	M3T10172,10271,10272,10372, 10473,10475,10476,10672
7 7382 1	M649T03571	
	with additional positive brushes 2 x JAS 70	
7 7183 1	M649T01371 M649T02271	M2T20181D,30481,30581,30981, 31081,32281,32581,32782D, 37081,41181,41182,42381, 42481,42781,42881,42981, 42985,43681,43781,43881, 44081,44781,48081,49281, 49282,49881 M3T10476D,21781D,21882D, 27686H,27781,27781D, 29482D,30081,30082,30281 30282,30285,30286,30381, 30382,30581,30781,30782, 30881,30981,32581,32582, 32583,32589,32591-32593, 32681,32782,32782D,33081 33182,33282,33581,33582, 33582A,33583,33585,33586, 33586A,33586D,33587, 33588,34782,35081,35082, 36081,37481,37781,37782, 38481,38581,38682,38881, 38881A,B,C,38882, 38882A,B,C,38883,38884, 38885,39385,39981,41081, 41083,41181,41285,41381, 41781,42781,42881,43881, 44081,70381,
	36170-21740	36100-11150,21760,21770
7 7383 1	M649T01371 M649T02271	
	with additional positive brushes 2 x JAS 83	
7 7184 1	M649T05072	M2T65271
	with 2 negative brushes 24V	
7 7384 1	M649T05072	
	with additional positive brushes 2 x JAS 97	

IKA-No.	Unit-No.
7 7185 1	M649T02171
	M2T60071-073,60171, 60185,60271,60371, 92071,92271
	with 2 negative brushes
7 7385 1	M649T02171
	with additional positive brushes 2 x JAS 71
7 7186 1	M649T05071
	M2T54172,54271,54371,54372, 54572,55971,56071,56171, 56181,56182,56271,56272, 56471,56472,56971,57271, 61071,61171,61371,61471, 61771,62271,65971
	with 2 negative brushes 12V
7 7386 1	M649T05071
	with additional positive brushes 2 x JAS 99
7 7187 1	M649T01271
	M1T70381,70481,70485,70781, 70881,71381,71881 36169-32510 36170-32500 HSP112110,1112130 MG112014,MP112023 36100-32510
	complete with positive brush-pair
7 7188 1	M649T01671
	M1T74081,74181,74281,74283, 74381,74481,74482,74581, 74583,74781,74781A,75181, 75281,75283,75381,75581, 75681,76081,76281
	complete with positive brush-pair
7 7189 1	M649T04471 M649X09571
	M2T25481 50181,50585,51085,52181, 52681,52881,52882,53181, 53781,53785,58581, M3T21882D 23300-00H10 23378-
	23378-N5912
	suitable for 2 and 4 brushes version
7 7389 1	M649T04471
	with additional positive brushes 2 x JAS 70



7 7150 0, 7 7151 0



7 7152 0



7 7153 0



7 7156 1



7 7157 1



7 7159 1, 7 7165 1





7 7146 1, 7 7147 1
7 7148 1, 7 7167 1

BRUSH-HOLDERS

VALEO

IKA-No.	OE-Ref.	Unit-No.
7 7150 1	181 961 594 072 brush length 14.5 mm w/o. brushes and springs -----	D6RA8,10 (PSX 146 - 147)
7 7151 1	183 957 186 381 594 070 brush length 16.5 mm w/o. brushes and springs -----	D6RA5,6,12,16,18,20,61 (PSX 148 - 149)
7 7152 1	for 4 brushes w/o. brushes and springs -----	D8E... / D9E... PSX 129 PSX 130
7 7153 1	for 2 brushes w/o. brushes and springs -----	D8E... / D9E... PSX 133
7 7156 1	for 2 and 4 brushes w/o. brushes and springs -----	D9R PSX 138-139 (2) PSX 140-141 (4)
7 7157 1	with 4 Springs and 4 caps w/o. brushes -----	D7R... PSX 142-143 PSX 142-144 PSX 142-145
7 7159 1	187 517, 187 626 594290 594351 complete with 4 brushes also suitable for 3 brushes version	D7E...1,4,6,8,15,16 18-20,22,27, 29-32,D28 SH clockwise PSX 155(3) PSA PSX 155(4) Mercedes A

IKA-No.	OE-Ref.	Unit-No.
7 7165 1	187946 594381 complete with 4 brushes -----	D7ES 2,4,5 SIH anticlock PSX 156 VW
7 7167 1	190097,190986,191821 complete with brushes -----	D7G... SH clockwise PSX 160-164 BMW
7 7146 1	190987,191824  complete with brushes -----	D7G... SIH anticlock PSX 163-164 VW
7 7147 1	191141,191823  complete with brushes -----	D7G... SH clockwise PSX 160-164 AUDI
7 7148 1	191060,191822  complete with brushes	D7G... SH clockwise PSX 160-164 PSA, Renault



B 68



B 104, B 140



B 131, B 145
B 169



B 135, B 165
B 181



B 151

BOSCH Dynamo Alternator

BX 68 (4)	1 107 014 118	12/24 Volt
4-B 68	2 104 320 105, WSK 38L2Z	6 x 28 x 30,5
	0 101 206 135,157 0 101 209 031,33,37,41 0 101 500 001,5,6,15,18,21,23,27 0 101 501 001,2,9,15,21,27-29,36,39,51,55,62-67 0 101 502 001 0 101 503 009 0 136 501,12,44 GQ300/12/950,400/24,GQL600/12/24 QL(R)14/28V/38/75A/14/15	
BX 104 (2)	1 107 014 116	12 Volt
2-B 104	2 104 320 074	6 x 22 x 25,5
	0 101 353 005,12,14,22,25,29,37 0 101 401 010,15 0 101 402 001,2,7,8,11,28,31,43,47,49,50,55-57, 060,63,64,67,71,72,76,78,79,86,90,100,106 0 101 404 013,16,19,20,23,26 GK200/12/24,300/12/24,GKM300/24	
BX 131	1 107 014 109	6 Volt
2-B 131	1 104 320 025	6 x 14 x 19
	0 101 202 010,16,22,23 0 101 203 002,3,5-9 0 101 205 009-12,14,16,19 0 101 206 007,24,25,27,29,32,33,35,37,38,44, 047,50,52,53,58,60,67,68,73-76,82- 084,86,87,91,96,98,120,122,147,148 0 101 207 009-11,13-15,18 0 101 208 002,10 0 101 209 007-9,25,26 0 101 212 001,3-8 0 136 200 007 REE75/6, REH90/6 GE, GEH, GEF, REF 130/160/6 REG 180/6, GEG 160/180/200/6/240/6/300/6 EH(L)7V23A, EG(L/R)7V50A/45A/30A	
BX 135	1 107 014 128	12/24 Volt
2-B 135	1 104 320 047 2 104 320 012	6 x 22 x 25
	0 101 302 022,23,25,26,29,35,39,44,47, 051,56,76,95,96,98,100,105 0 101 356 007,9,26 GJA160/12; GG130/160/240/12	
BX 140 (2)	2 107 014 007	24 Volt
2-B 140	2 104 320 084	6 x 22 x 25,5
	0 101 206 012 0 101 402 010,11,59-64,73,78-80,83-85, 087-92,97,99,100,905,906 0 101 404 011,13,19,23 GK300/24,K(R)28V13A	

BX 145	1 107 014 135	6/12 Volt
2-B 145	1 104 320 031	6 x 14 x 19
	0 101 204 014 0 101 206 014,18,30,34,54,57,59,61,62, 064-71,87-91,113,115,117,119,132 0 101 208 003,5,7,11 0 101 209 002,3,7,14,18,21-23,26-29,31-33, 536-41,43-47,60,64,65 GEG200/6, EG(R)7V50A; EF/EG/EH14V20-25A	
BX 151	1 127 014 000	12 Volt
2-B 151	1 124 320 000	10 x 5 x 18
	0 120 400 507, 10, 17, 19, 22-24, 26, 29-31, 533-37, 40 DK1/14V35A	
BX 165	1 107 014 140	12 Volt
2-B 165	1 104 320 014,44	6 x 22 x 25
	0 101 203 067 0 101 302 067,68,70,74-76,83-86,89, 107,8,11-20 0 101 304 002-5,7,9,13,14,16-18 G(L/R)14V30/38A	
BX 169	1 107 014 144	12 Volt
2-B 169	1 104 320 037	6 x 14 x 19
	0 101 100 015 0 101 200 034 0 101 201 020-23,25,28 0 101 202 022 0 101 203 007,9 0 101 204 014 0 101 205 010-12,14,16,19 0 101 206 009,11,12,14,18,26,30,34,43,54,57, 059,61-66,70-72,79,81,84,87,89,91, 099-110,113,115-117,119,120,123, 125,132-141,145-147,149-152,157 0 101 207 005,18 0 101 208 003,5,7-11 0 101 209 002,3,7,14,18,21-23,26-29,31,33, 036-41,43-47,60,64,65,67-69 0 101 352 005,8 0 101 354 023 0 101 355 040 EG(L/R)14V25-38A EH(L/R)14V11-20A GEGM200/12/2700	
BX 181	1 107 014 146	12 Volt
2-B 181	2 104 320 012 1 104 320 047	6 x 22 x 25
	0 101 302 002,6-8,13-16,21-29,35,36,39,44, 047,51,56,68,69,76,86,89,95-101, 105,112,113,118 0 101 304 001,14,15 0 101 355 040 0 101 356 003,5,7,9,11-14,23,26 0 136 301 001 G(R)14V30A	



**B 182, B 190
B 198**



B 185



B 188



B 192



B 199



B 202

BOSCH Dynamo Dynastart Alternator

BX 182	1 127 014 009	12 Volt	BX 190	1 127 014 012	12 Volt
2-B 182	1 124 320 029	10 x 5 x 17	2-B 190	1 124 320 025,43,57	10 x 5 x 17
	0 120 400 600-6,8,9,11,14,15,20-31,34, 635,37,43,44,47-50,52-63,71, 672,75,77-82,86,87,92,93, 700, 2,3,9-14,16,17,19,21, 726-31,36,52,53,56,57,64,65 765-77,86,87,89,92-95, 800, 1,2,23,47,48,70,71,93-96 920,34,40 K1(L/R)14V35/55A20 28/45/50/55A22 K1-14V35A20,45A24		0 120 340 001-6,8 G1 14V20A -----		
BX 185	1 127 014 011	12 Volt	BX 192 (4)	2 107 014 012	12/24 Volt
2-B 185	1 124 320 027	8 x 5 x 15,5	4-B 192	2 104 320 064	8 x 28 x 33,5
	0 120 300 510-19,22,23,28-40 543-52,55,58-64,67,69, 573-80,85-90,92, 339 539 400 669,70, 704-07,22-24,33,40-43,45,47, 758,59,71,72,82,83, 806-11,14,27,28,31-34,36,37, 839-41,49-61,63-69,72,73,85, 889,90,98,99, 900-03,06,08,10-19,21,22, 926-28,36,37,43 450 003,4,7, 489 059,678,776,78,87,88,832,97, 955,98,99 9 120 143 000-003,6,7,9-11,15-17,20,21, 023,25-28,32-34 201-4,18,22,23,25, 144 002,5,10,11-14,18-20,22,24, 026,27,28,30,32,34,35,37, 039,40, 218-20,29-33,39,59,60-64, 272,74-76,94,96-98, 303,11 G1(L/R)14V15/18V20 28A22,33A27 G1-28V17A27 K1(L/R)14V35/38/50/55A20, 43/50A21, 35/45/60A22, K1(L/R)14V20/38/45/60A, 21/50A,23/55A,28/70A		0 101 209 060,65,68 301 010 302 022,25,27,29,35,39,44,56,84,105,111 601 003,5 21, 22, 24, 73, 92, 93, 96, 98, 100, 102-104, 106, 114, 116, 118-120, 122, 126, 128,130, 140, 142,148,149, 160, 166, 168, 171-179,186, 189-191, 194, 195 690 004 GTL700/12/24, 1000/12/24 TL 28V62A,UT1200/24 -----		
BX 188	2 017 014 100,105	Startergenerator	BX 198	1 127 014 014	24 Volt
4-B 188	2 014 320 012	6 x 14 x 23,5	2-B 198	1 124 320 002	10 x 5 x 17
	0 010 300 001-4,6,13,100,101 0 010 350 003-7,9,11-20,100-106 0 101 350 004 0 136 351 006 EJ160/12/3000 J(R)14V11A32 RL14V11A32		0 120 400 504,5,7,8,10-12,17-19,22-25, 528-34,36,40-42,47-49,51-55, 558,63,66-72 617-19,32,33,36,39-42,45,64, 666-68,73,74,83-85,88-91,94, 695,97-99, 701,8,15,20,32,37,54,55, 773-75,78,79,85,88,90,91, 796-99, 805,24-26,30,35,42,43,45, 846,74-78,81-84,86-88, 891,92,97, 904,5,7,25,29-31, 9 120 690 024 K1 14V50A17,50A19,35/55A20 K1 28V17/25A19,21A21,27A23,35A24,45A27 K1-14V 16/35A K1-28V 3/45A,7/27A,8/35A -----		
			BX 199	1 127 014 015	12/24 Volt
			2-B 199	1 124 320 039	8 x 5 x 15,5
			0 120 400 665 725,60-63,84, 829 489 793,94,96, 9 120 144 006-8,101-5,107,109,110 K1 14V55A20 K1 28V18A5/A21,35A8/A24 K1 28V 5/18A,7/27A,8/35A -----		
			BX 202	1 127 014 013, 017,020	12/24 Volt
			2-B 202	1 124 320 046/054	8 x 5 x 19,5
			0 120 400 944,45,47-54, 450 001,2,10-29 469 580,691,752,53,73,850,51 484 045,46 489 034,658,709,891,900,995 9 120 144 124,125,130,133 K1-14V23/65A,35/75A,40/90A K1-28V 7/27A,8/35A N1-14V29/90A,30/85A,31/70A,40/100A,50/120A N1-28V10/55A		



B 203



**B 204
B 209**

BOSCH Alternator

BX 203	2 127 014 003,005	24 Volt	BX 209	1 127 014 021 (019)	12/24 Volt
2-B 203	2 124 321 005	10 x 5 x 22	2-B 209	1 124 320 061	8 x 5 x 15,5
	0 120 600 515,21,25,27,38-40,43,44,54, 554,58-71,73-81			0 120 339 502-506,509-526,527,528,531-538,543-546 400 938,939,941,942 450 009 469 500-507,510-513,515,517,524,525,528,531, 533-535,537,539,570,573,574 489 001,019-021,047-052,054,074,075,309,475, 481,500-502,506,508-514,519-523,526,527, 532-536,538,541-551,556-562,565,566, 568-570,572-578,580-582,586,588,590, 593-595,599-605,607-611,613-617,619-624, 626-636,638-640,642,644-650,652,654-657, 659-661,664-669,671-673,676,678-683, 686-688,692,699,701,706,711,712,714, 716-722,732,735,739-743,745,747-749,751, 753,755,758,760-763,765,767-770,772,774, 775,780,781,783,785,786,795,797,798, 800-804,806,809-811,813,815,817,819, 821-826,828,829,833,835-844,847-857,859, 860,862,864,866-869,871,873-875,877-880, 887,893-896,899,914,916,919,921,922,924, 938-940,942,943,947-952,956-959 888 888 9 120 143 035,036,205-210,212,214,215,224,227-229 144 016,100,106,108,202-204,209,215,221-224, 227,238 334 140 690 006,007,012-015,020,021,025,081,082 G1 14V 28-35A G1 28V 3/18A K1 14V 35-70A K1 28V 7/27A, 8/35A N1 14V 70-90A	
BX 204	1 127 014 022 (018,023, 025,029, 030)	12/24 Volt			
2-B 204	1 124 320 069 (070,079) w./o. springs and rivets	8 x 5 x 19,5			
	0 120 339 547 450 030,31 468 001-147,149,154,155,159-162,999 469 001-041,043,044,048,100-105,107-118, 518-523,526,532,540-549, 551-564,566-569, 571,572,575,576,578,579,581-595,598-611, 617-624,628-653,655-662,664-677,679-690, 692-709,711-751,754,757-759,761-763,768, 772,774-797,799-802, 804-823,827-839,843, 849,852-865,868-871,873-879,881-897,899, 900-916,918-953,955,956,958-960,962,963, 966-985,988-999 484 001-027,035,040,041,050,051 488 000-012,100-103,109-112,114,115,118-126, 129-153,156-205,207-211,214,215,217-241, 243-247,249-293,295,299-304,306,308-316 489 002-018,022-033,035-046,055,057,058,061-066, 069,070,072,073,076-084,086-088,090-101, 103-156,162,167,168,170-176,181-184, 186-220,224,226-229,232-239,242-254, 258-263,266-269,272-279,282-283,285-292, 294-305,307,308,310-398,400-405,408, 410-413,418-452,455-457,460,461,465-467, 469-474,476-480,482-499,507,643,702-704, 707,710,723-726,728-731,733,737,756,757, 779,827,881,882,885,886,888,889,901-906, 909-912,917,918,928,930-933,935,936, 944-946,960,961,964-978,980-997 6 033 G00 1BY G30 03B,14B,30B,31B,37-40B, 43B,57B,40B,58B,60B G3B 022 G40 11B GB2 009 GB3 006,08-10,14,19-23,27,30,31, 033,36,40,46,47,54,55,59 GB4 008,09,15-18,20,21 GB5 007,09 9 120 080 129,135 143 018,019, 144 111-123,126-129,131,132,136,137,139, 205-207,216,217,235-237,240-245,248-258, 265,266,269,270,279-282,284,286-290,292, 301,305,600-628,631,636 334 135-139,310,312-318,320,322-324, 326-328,625-628,631,635,636 335 003 690 095,098,150,152,154 9 121 337 079 K1 14/28V 35-120A N1 14/28V 55-140A NL1 28V45-80A				



B 213
B 219



B 214



B 215



B 216



B 220

BOSCH Alternator

BX 213	1 127 014 028	12/24 Volt
2-B 213	1 124 320 076,077,078	6 x 4 x 17,5
	Regulators with monolithic circuitry Regulator-Nos.:	
	1 197 311 212-214,221-223,225,230,231,233-236, 238-240,242,501,503,508-511,513,514, 519-523,525,526,528-530,533,539-541, 543,545,547-553,555-558	
	slip ring diameter 14mm	
	0 120 335 006-008,010-012, 465 003,004,006-018,020,021,023,026-029,031, 485 005-008,011,012,015,017-020,022-026,028-030, 032,034,036,038,039,041,043,044,046-050	
	0 123 100 001-003 105 001,002 110 004-008 114 005 115 009-014 120 001 212 001 215 001 310 001-008,010-020,022-035,037-044,046-055 315 001-008,013,015-022,500-503 320 001-012,014,016-055,057-063,065-067 325 002-008,010-014,500 335 001-006,008 340 001-003,005-007 345 004 500 001,002,004-009 505 001-005,007-018 510 001-018,020-023,026-034,037-054,056-075, 079-082,088,089,091-096,099-102,105-109 512 500-502 515 002-004,007-014,016-018,020-025,028,030,031, 500-503 520 001-008,010-015,017,019-023,026,027,029-031,500 525 001,500-503 540 001-004 545 001-004	
	0 124 515 503 F 010 LD0 201,202,205,206 GC 14V,50-70A KC 14V, 37-95A NC 14V, 55-150A	
BX 214	1 127 014 024	12/24 Volt
2-B 214	1 124 320 073	8 x 5 x 17,5
	0 120 489 293,309,475,481	
	K1 14/28V, 45-65A	
BX 215	1 127 014 016, 026, 027 6 033 RD7 001	24 Volt
2-B 215	1 124 320 075	8 x 5 x 24,2
	0 120 469 710 689 502-08,10-18,20-28, 530-35,38-41,43,45,46, 548-53,55,57-59,61,63 564,67,69,71-77,82-85, F 000 LD0 207, 208,210 T1 28 V 105-140A	

BX 216	2 127 014 006,007,008	24 Volt
2-B 216	2 124 321 007	10 x 5 x 26,5
	0 120 600 582-592 689 519, 29, 36, 37, 44, 47, 54, 56, 60	
	T1(R/L)28V44/55A,51/85A, 60/89A,110/180A -----	
BX 219	1 127 014 031	24 Volt
2-B 219	1 124 320 080	8 x 5 x 17,5
	w./o. springs and rivets	
	0 120 469 847,848 488 206, 294	
	K1 28V, 45A-90A	
BX 220		12/24 Volt
2-B 220	w.spring and plastic part	6 x 4 x 17,5
	Multifunction regulators for Compact alternators	
	Regulator-Nos.:	
	F 00M 145 200,201,206-211,213-215,217-220, 222,224-231,233,235-249,251,252, 254-261,270,271,282,404	
	slip ring diameter 28mm	
	0 124 215 001-006,008 225 001,002,004,009,012,016,018-030,032-036, 038,039,045,047 315 001-008,010-016,018-022,024-027,030 325 001-004,006-024,028,031-037,039-067,071, 073-076,079,085,086,088,094,097,100,101, 105,107,109-115,119,120,125 415 001,002,005-016,023,025,026,028,030,032,033 425 004,006,009,010,019,021,022 515 001,004-006,010-013,015-019,022-028,031-035, 038-050,054-062,064,068,073,079,080,082,083, 085-087,089-091,095,096,101,103,109,110-113, 116-118,120,121 525 001,008-010,014,016,017,019-022,027,030,039, 040,056-058 555 001-008,012-016,020,024,027,035 615 002,006-009,012-017,019-021,024,026,027,030, 031,035 625 005,007,018 655 001,002,004-008,012,013,016, F 000 LD0 700	
	E4 14V 50-110A E6 14V100-120A E8 14V 75-140A GCB2 14V 38-70A KCB1 14V 50-90A KCB2 14V 55-105A LI-E 14V 55-110A NCB1 14V 70-120A NCB2 14V 90-150A	



BS 12, BS 39



BS 33, BS 34
BS 35, BS 36



BS 43



BS 44



BS 59



BS 62, BS 67

BOSCH Starter

BSX 12	1 007 014 100	6/12 Volt	BSX 44 (4)	2 007 014 006	12 Volt
4-BS 12	2 004 320 006	9 x 13 x 25,5	4-BS 44	2 004 320 074,80,85	8 x 22 x 22,5
	0 001 354 006,12,16,18,25-27,29,31,33,34,36, 038,42,48,55,62,64,68,70,73,74,77, 079-96,98-100,3,6,8,9,13			0 001 356 003 358 005,10,14,17,18,20,21,23,26-28, 033,35,37,38,40,41,46-51,90	
	0 001 355 012 356 001 363 001			EJD 3/12 JD(R) 3.2 kw -----	
	9 000 143 200,1 EJB,EJC,EJD1.6/1.8 kw JD (R/L) -----		BSX 49	1 107 014 126 = BSX 76	1 007 014 121
BSX 33	2 007 014 020	12 Volt	-----		
	1 007 014 106		BSX 59 (2)	1 007 014 112,117	12 Volt
4-BS 33	2 004 320 066	9 x 20 x 28,5	2-BS 59	1 004 320 125	7 x 16 x 18
	0 001 400 016 0 136 401 005 BNG 2,5/12; 4/12 -----			2 004 320 154	
BSX 34	2 007 014 021	24 Volt		0 001 208 001,14,30 209 014 211 001-3,5,6,10,12,13,17,18,20,22,23,26 212 002,5,6 217 001 311 020-24,28,30	
	1 007 014 107			9 000 042 027 EF(L/R) 0,7/0,8/12; EB(L), EEF 0,8/12 -----	
4-BS 34	2 004 320 068,87,	9 x 20 x 28,5	BSX 59 (4)	1 107 014 117 (x 2) = BSX 76	1 007 014 121
	0 001 401 071 402 001,7-9,11,12,18,23,34,41,43,44,50, 052-61,65,66,68,69,71,72,74,75,77, 079-81, BNG, KG(R) 4/24 -----		-----		
BSX 35	1 007 014 109	12 Volt	BSX 62	2 007 014 011	12 Volt
	(2 007 014 047)		4-BS 62	2 004 320 203	10 x 25 x 23
4-BS 35	2 004 320 091,98,	12 x 20 x 28,5		0 001 359 001,4,6-8,11-14,16,18,19,21, 024-26,28,30,31,33-35 9 000 143 000-2	
	0 001 401 002,4-7,11,13,15,17,26-29,35-37,39, 041,43-47,49-53,57,60-62,66-71,73 KG(R) 3.0 kw -----			JD(R) 4/12 IDR 12V28 -----	
BSX 36	1 007 014 105	24 Volt	BSX 67	2 007 014 012	24 Volt
			4-BS 67	2 004 320 141,207	8 x 25 x 23
4-BS 36	2 004 320 053	12 x 36 x 30		0 001 360 002-5,8,9,12,13,20 JD 4/24	
	0 001 501 001-3,5,6,13,14,19,24,31,32,34,35,38,41 QD 24V 5,5 KW -----				
BSX 39	2 007 014 002	24 Volt			
4-BS 39	2 004 320 008	9 x 13 x 25,5			
	0 001 355 009,11,13,15-17,19,20 EJD 1,8/24				
BSX 43 (4)	1 107 014 110	6/12 Volt			
4-BS 43	1 004 320 059	7 x 16 x 22			
	0 001 203 005,8-11,16,19 204 005 205 003,5,7,9,10,12,13,15,17 217 001 304 002,10,12,13,16,19,23 305 001,2,8,10-13,16 306 011,13 307 004,7-12,14-17,19-22,24,25 309 001 312 001 EED 0,5/6; 0,8/12; EGD 0,5/0,6/6,1/12; EGE 1/1,3/12				



BS 70
BS 76



BS 74



BS 75



BS 93



BS 96
BS 100



BS 97



BS 98



BS 102

BOSCH Starter

BSX 70	2 007 014 018	12 Volt
4-BS 70	2 004 320 026/098	7 x 14 x 16
	0 001 155 016,017 157 001-4,6,7,13,14,18 DD(R) 0.5PS/0.6kw DF(L/R) 0.6PS/0.7kw -----	
BSX 74	2 007 014 000,024	12 Volt
4-BS 74	2 004 320 043,044	7 x 14 x 17,5
	0 001 100 003,004 101 004 102 003-006,009 104 005,007 105 002,003 154 001,005,007 155 001-004,006,008-010,014-016 157 010 158 001,002,008,009 9 000 141 000-004,006-010,013,015,017,018 DC(L) 0.5kw DD(L/R) 0.6kw DF(R) 0.65kw -----	
BSX 75	2 007 014 026	12 Volt
4-BS 75	1 004 320 076,126 2 004 320 172,173,180	7 x 10 x 18
	0 001 208 039-41,44,49,51-54,100 211 200,1,4,6,9,989-91,97,98 212 006-8,11,13 EF(R/L) 0,7/0,8/12 -----	
BSX 76	1 007 014 119,121	12 Volt
4-BS 76	1 004 320 071,082,127	7 x 16 x 18
	0 001 207 001-3,5-7,9,10,13,15-20 208 004,6,7,9-12,17-19,23,25,29, 033,36-38,46,48,50,54,55 212 002,3,5,6,12 214 001 217 001 310 002,5,7-11,16,18,43,46,47, 049,50,116,120 311 008,10,13,19,23,25,28-31,35-37 314 009 EF,EEF(L/R) 0,7/0,8/12;GF(R) 1/12 -----	
BSX 93	2 007 014 016	24 Volt
4-BS 93	2 004 320 122,125,127	9 x 16 x 25,5
	0 001 363 001,101 JF(R)2.8PS/2.6kw -----	
BSX 96	2 007 014 052	12 Volt
4-BS 96	2 004 320 220	10 x 25 x 23
	0 001 358 200-2 359 001-4,6-8,10-14,16,18-21,23-41, 043-51,53-69,71-76,81-92,94-102 104-14,17-19,22,24 365 004-008 9 000 143 107,9-11 JD(R) 3.0/3.7kw,4PS	

BSX 97	2 007 014 057 (1 007 014 130)	12 Volt
4-BS 97	2 004 320 033	9 x 16 x 17
	0 001 305 010 315 002,004,005 362 034-43,45-53,57-64,67,69-79,81-83, 097-100,102,103,111,322, 602-603,607,700,703, 363 104,5,7,9,11,13,16,116 366 001-6,8-22-24-29,46 9 000 143 204,408,420 GF(L/R) 1.6/1.9kw JF(L/R) 1.9/2.0/2.3/2.4/2.7/3.2kw	
	Alternative Brush-Sets: BSX 137-143 2 007 014 065 / 068 w. flex and terminal BSX 139 2 007 014 040 w. flex only -----	
BSX 98	1 007 014 126,133	12 Volt
4-BS 98	1 004 320 900	7 x 10 x 18
	0 001 207 001,018, 208 004,8,25,44,49,51-54,100,101, 200-5,6,8-11,13,14,16-21,23-29, 32,33 403-409,11-23,25-29, 211 200,1,4-9,10,13-25,27-29,33-36,39,41-49, 251-55,57-59,86,88, 986-93,95-96 212 006,204-14,400-3, 213 003,4 9 000 142 001-003,14,100-102, 333 105,112, 115,116,118,119 EF(L/R) 0.7-0.95kw	
	Alternative Brush-Set: BSX 75 2 007 014 026 with flex -----	
BSX 100	2 007 014 049	24 Volt
4-BS 100	2 004 320 217	8 x 25 x 23
	0 001 360 002,3,7,8-10,12-19,22-27,29-45, 047-51,54-61,63-65 364 100,6,8,200-6 416 015 417 060 9 000 143 300-5,501 JD(R) 4.0/4.8/5.2/5.4/6.6kw -----	
BSX 102	2 007 014 053	12 Volt
4-BS 102	2 004 320 124,126	9 x 16 x 25,5
	0 001 357 002, 362 001-9,11-17,19, 021-25,27-30,32,33 9 000 143 400,2,4-7,9 JF 2.0/2.4 kw	



BS 104



BS 121,BS 124
BS 133



BS 116



BS 127



BS 130



BS 134, BS 135
BS 137, BS 138



BS 142, 143
BS 144, 145



BS 139

BOSCH Starter

BSX 104	2 007 014 054,055	12 Volt
2-BS 104	1 004 320 082/127	7 x 16 x 18
	0 001 208 009,13,24-26,31-33,58,59,61 211 001,2,4,16,21,23-25 215 001 311 001,7,14,16,26,27,32,38,39,45,48 313 001,3-5 EF/GF(R) 0.85 kw 1 PS -----	
BSX 116	2 007 014 058	24 Volt
4-BS 116	2 004 320 035	9 x 16 x 15,5
	0 001 363 103-113,115,117,124-127 IF(L/R) 2.6/3.2 kw Alternative Brush-Set: BSX 138-142 2 007 014 069 w. flex and terminal -----	
BSX 121	1 007 014 128	12 Volt
4-BS 121	1 004 320 902	7 x 14 x 16
	0 001 157 003,4,6,7,13-16,18,21-25,27-30 9 000 141 101,3,4,7,8,11-16,100 334 101-104 DF(L/R) 0,6-0,7 kw Alternative Brush-Set BSX 70 2 007 014 018 with flex -----	
BSX 124	1 007 014 127,129,134	12 Volt
4-BS 124	1 004 320 901,903	7 x 16 x 18
	0 001 207 001,003,005,009,015,018,019 208 004,006,007,017,018,032,038,046-050, 208 046,047, 055,056,058,059,061 209 014 211 005,016,017,129 212 001,005,006, 214 002 215 001,002 310 007,018 311 001,016,023-025,029-32,034,045,047 050-052,054-056,100,103,105,107,108,112-115, 118,120-128,130,131,133-143, 146,147,149-152 312 100-102,104-107,110,111 313 006,007 314 001,003-006,008-018,022,024-049 317 005,006 EF(L/R) 6/12 0.5-0.85 kw GF(L/R) 6/12 0.5-1.70 kw Alternative Brush-Set: BSX 76 1 007 014 021 with flex -----	
BSX 127	1 007 014 132	24 Volt
4-BS 127	1 004 320 906	7 x 10 x 18
	0 001 204 102 EFL 24V/1,1KW	

BSX 130	2 007 014 059,060	12 Volt
4-BS 130	2 004 320 263	12 x 36 x 27
	0 001 413 001-14,17,18 418 001-17 KB(L/R) 3.5/3.6 kw -----	
BSX 133	1 007 014 135	24 Volt
4-BS 133	1 004 320 909	7 x 16 x 18
	0 001 316 001-3,6,8-13 GF(R) 1.5/1.6 kw -----	
BSX 134-144	2 007 014 062	12 Volt
2-BS 134	2 004 320 101	10 x 25 x 17
2-BS 144	2 004 320 102	10 x 25 x 17
	0 001 367 001-18,20-46,48,50,51,54-59,61-64, 066-68 9 000 143 410,12,15,16,19 JF(R) 3.0 kw -----	
BSX 135-145	2 007 014 063	24 Volt
2-BS 135	2 004 320 103	8 x 25 x 17
2-BS 145	2 004 320 104	8 x 25 x 17
	0 001 368 001-88 300-321 300-321 369 011 9 000 143 600-04 JF(R) 4.0 kw -----	
BSX 137-143	2 007 014 065,68	12 Volt
2-BS 137	2 004 320 294,296	9 x 16 x 17
2-BS 143	2 004 320 295,297	9 x 16 x 17
	0 001 362 034-36,38-43,45-53,057-64 067,69,70,81-86,88-100,102-105 300-332,600-607,700-705 366 001-6,8-22,24-29, 9 000 143 203,4; 408,11,13,14,20 JF(L/R) 1.9-2.7 kw -----	
BSX 138-142	2 007 014 069	24 Volt
2-BS 138	2 004 320 298	9 x 16 x 15,5
2-BS 142	2 004 320 299	9 x 16 x 15,5
	0 001 363 003-5,7,9,13,16 103-128 JF(L) 3.2 kw JF(R) 2.6/3.2 kw -----	
BSX 139	2 007 014 040	12 Volt
4-BS 139	2 004 320 038	9 x 16 x 17
	 Alternative Brush-Set for BSX 97 2 007 014 057 with bore	



BS 140
BS 146

BS 147
BS 153

BS 148

BS 149
BS 152

BS 151

BS 151/0



BS 155

BS 155L

BS 157

BS 158

BOSCH Starter

BSX 140	1 007 014 138	12 Volt	BSX 151/0	1 007 014 143 w/o. clip	12 Volt
4-BS 140	1 004 320 910	7 x 16 x 15	4-BS 151/0	1 004 320 112	7,5 x 18 x 17/19
	0 001 208 516,710 211 514 312 108,9 317 007-13,16-19,22-25 0 136 300 007 GF(R) 1,7 KW			Alternative Brush-Set for BSX 151 1 007 014 143 w. clip	
BSX 146	1 007 014 137	12 Volt	BSX 152	1 007 014 144	12 Volt
4-BS 146	1 004 320 911	7 x 10 x 14	4-BS 152	1 004 320 106	7 x 16 x 15
	0 001 211 500-505,7,10,11 525-30,38			0 001 317 014,15,20,21 GF(L) 1.7 kw	
BSX 147	2 007 014 067 3T0844 Caterpillar	24 Volt	BSX 153	2 007 014 066	12 Volt
4-BS 147	2 004 320 017	10 x 36 x 27	4-BS 153	2 004 320 016	12 x 36 x 27
	0 001 420 001-15,24-29 3T4583,6 Caterpillar KE(R) 7,5 KW			0 001 421 001-10,14,15 KE(L/R) 5,5 KW	
BSX 148	2 007 014 070	24 Volt	BSX 155	2 007 014 071	12 Volt
4-BS 148	2 004 320 285	12 x 36 x 27	2-BS 155	2 004 320 135	10 x 25 x 15
	0 001 410 029,062 416 001-40,42-77 417 001-74		2-BS 155L isol.	2 004 320 136 isol.	10 x 25 x 15
	KB(L/R) 5.4-6.6 kw		Alternative Brush-Set for BSX 134-144 2 007 014 062 w. terminal BSX 163-164 2 007 014 073 w. terminal		
BSX 149	1 007 014 139,141,145	12 Volt	BSX 157-158	Brush-Holder:	12 Volt
4-BS 149	1 004 320 101,102,103	7 x 10 x 14	2-BS 157	1 004 336 800,02-04,07,08,19,26,29,35, 836,39,40,45,47-49,52,83, 906,08,09,14,24-27,31-33,42, 945-49,55,56,58,59,62,76,81, 983,84,88,90,91,94,96,97,99	
	0 001 208 501,6-8,10,13-21,26,28 702,5-15,17-19, 211 512,13,15,33,35,36 1 001 711 512,13,15 9 000 333 104,06,09,14,17,20,21 EF(L/R) 5.4-6.6 kw Alternative Brush-Set for BSX 146 1 007 014 137 w. clip		2-BS 158	1 004 320 110,135,143,148,166,218 1 004 320 111,134,142,149,165,219	6 x 18 x 13/14,5 6 x 18 x 13/14,5
BSX 151	1 007 014 143	12 Volt		0 001 109 001-003,06,07,11,12,14, 015,18,23,25,28,29,31 033-035,40-45,47,61, 110 001-004,07,08,11-15,18,19,22-24 026-33,39-49,51,53,55-67,70,71, 073,75-80,81,83-85,88-90,92,95, 098-102,104-07,10-15,20,22-24 999 115 001,002 124 004,15 125 001,02,05,06,09,10,12,13,16-19 021,22, 501-04,07,08,12,13,17 602 F 010 AL0 101 DB/DW (L) 1,7 KW DW (R) 1,6-2,0 KW flex section 4.0 qmm	
4-BS 151	1 004 320 912,9 003 334 315	7,5 x 18 x 17/19			
	0 001 218 001-29,100-178 9 000 331 401,2,5-9,11-15,17-28,30-33 6 033 AB1 300 EB(L/R) 1.9/2.2.4 kw EV(L/R) 1.9/2.2/2.4 kw				



BS 157K
BS 160



BS 158K
BS 159



BS 163
BS 170



BS 164
BS 171



BS 165



BS 166





BS 172

BS 173







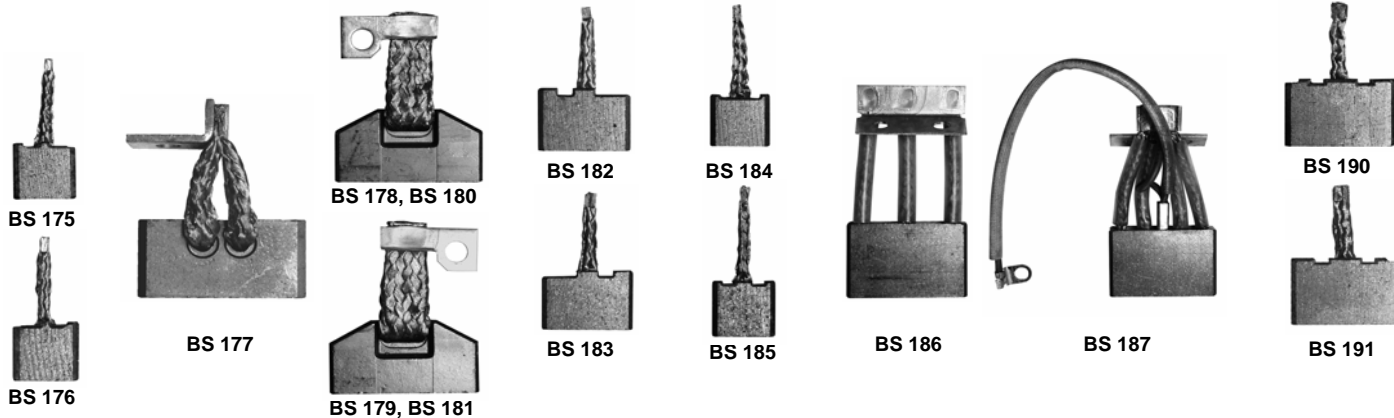

BS 174

BOSCH Starter

BSX 157-158K	Brush-Holder: 1 004 336 824,867,899	12 Volt	BSX 166	Brush-Holder: 1 004 336 217	12 Volt
2-BS 157K	1 004 320 153,171,173,221,222	6 x 18 x 11/12,5		815,17,34,43,44,46,65	
2-BS 158K	1 004 320 152,172,174,220,223	6 x 18 x 11/12,5	4-BS 166	915-17,28,39,40,43,52	
	0 001 115 005,006,008,009			953,63,67,69,92,93	
	DW (R) 1,7 KW Daimler Benz flex section 4.0 qmm			1 004 320 136/F 000 AL1 658	
BSX 159-160	Brush-Holder: 1 004 336 806,11,12,16,23,32,37,50,59, 902-04,07,11-13,18,19,21-23, 934-36,41,44,50,54,60,61,65, 968,71,73,74,86,95,98	12 Volt		0 001 112 003-16,19-25, 027-29,32,39,41,44,45	
2-BS 159	1 004 320 113,123,133,140,146,167, 224,226	5 x 16 x 11,5/13		113 001-15	
2-BS 160	1 004 320 114,124,132,141,147,168 225,227	5 x 16 x 11,5/13		114 003-06,08-10,14-18 020-22	
	0 001 108 001,02,05,09-13,16-33,35,37, 040,43-48,50-54,56-66,68,69, 071-79,81-100, 103-12,15-27,29,31-33,36,37, 139-41,44-54,56,58-60,62, 168-73,77,78,80-82,84,86,99 996-999 111 001-05 F 010 AL0 101 DW (R/L) 1,1-1,4 KW flex section 4.0 qmm		BSX 170-171	133 003,04 9 000 081 003,10 F 000 AL0 302,400,401	
				DA (L/R) 0,9 KW DM (R/L) 0,8-1,0 KW	
BSX 163-164	2 007 014 073,76	12 Volt	2-BS 170	2 007 014 077, 085	24 Volt
2-BS 163	2 004 320 108	10 x 25 x 15	2-BS 171	2 004 320 196, 165	10 x 25 x 15
2-BS 164	2 004 320 109	10 x 25 x 15		2 004 320 197, 166	10 x 25 x 15
	0 001 367 001,04,05,07-10,12,15,17, 018,21,23,32,44,47,49,50, 052,54,61,63,65,66,69-82 300-03, 369 002,05-07,12-25, 200,01 9 000 143 416 JF(R) 3.0/3.1/3.6 kw			0 001 364 300,301,400,402	
BSX 165	9 003 337 001	24 Volt		372 001-008	
4-BS 165	9 003 334 321	7,5 x 18 x 17/19		JD(R) 5,2 KW JE(R) 6,2 KW JF(R) 4,8 KW	
	0 001 219 001-14 9 000 331 201,203 332 401,402,405,406			Brush-Holder 2 004 336 066,085-087	
	EV (R/L) 2,5 KW		BSX 172-173	2 007 014 079	24 Volt
			2-BS 172	2 004 320 244	12 x 36 x 19
			2-BS 173	2 004 320 245	12 x 36 x 19
				0 001 410 029,62	
				416 001-14,16-19,22,24-33, 035-40,42-53,56,57, 059-66,68-80	
				417 001,02,04-07,10,11,13, 014,16,17,20,22-31,33, 035-38,41-45,47,48, 050-59,61-66,68,69, 071-74,77,78, 418 004-06,08,10	
				Replacement for BSX 148 KB(R) 3.6/5.4/5.5/6.6 kw	2 007 014 070
			BSX 172-173-174	2 007 014 084 VOLVO 3093273	24 Volt
			2-BS 172	2 004 320 244	12 x 36 x 19
			1-BS 173	2 004 320 245	12 x 36 x 19
			1-BS 174	2 004 320 249	12 x 36 x 21
				0 001 417 075,076	
				Volvo Starter-No. 1547049,1556955 3095060,3964839	
				KB (R) 6,6 KW	







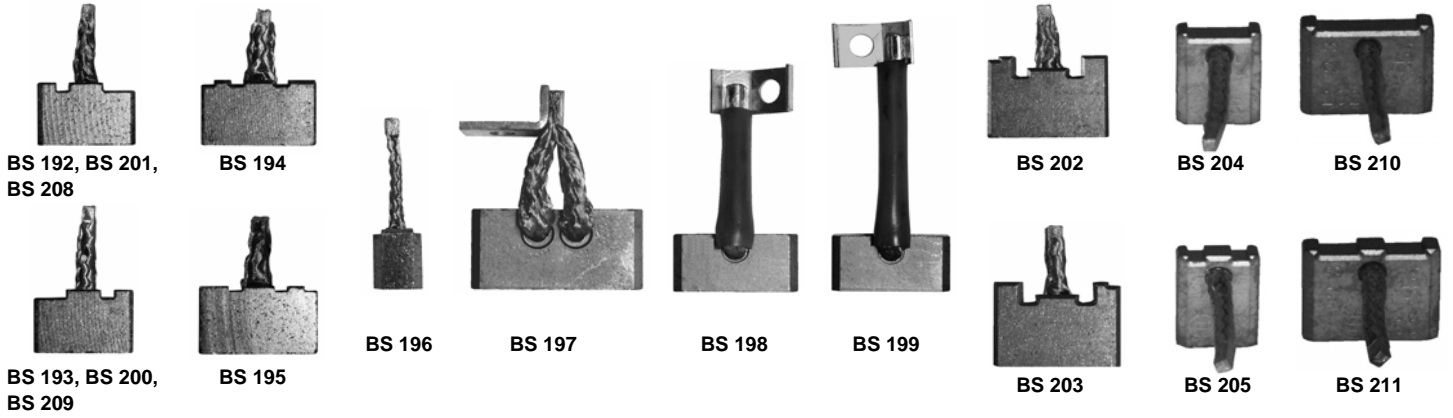



BOSCH Starter

BSX 175-176	Brush-Holder: 1 004 336 801,09,10,13,14,20,21 827,28,30,31,33,41,42, 851,53, 937,38,51,57,64,70,75,80 985,87,89	12 Volt	BSX 184-185	Brush-Holder: 1 004 336 866,887,896	12 Volt
2-BS 175	1 004 320 154,156,169,214	5 x 12 x 10,9/11,6	2-BS 184	1 004 320 163,200	4,6 x 12 x 10,5/11,2
2-BS 176	1 004 320 155,157,170,215	5 x 12 x 10,9/11,6	2-BS 185	1 004 320 164,201	4,6 x 12 x 10,5/11,2
	0 001 106 012,14,17,22-24, 107 009-12,14,17-19,24,25-34,37-40, 043,45-48,52-56,58,59,62-64,70-75, 070-75,77-80,82,87-90,94-98 121 001-03,06-09,16,17,19,22,23 9 000 081 001, 04,06,07			0 001 107 401-404,406,407,410,411,415 R70-M15(R) DW(R) 1,1 KW Mercedes A, C Opel -----	
	DB/DW (L) 1,1 KW DW (R) 1,0-1,2 KW flex section 2.5 qmm -----		BSX 186	2 007 014 017	24 Volt
BSX 177	2 007 014 082 9 001 453 644	24 Volt	4-BS 186	2 004 320 176,178	12 x 40 x 27
4-BS 177	2 004 320 271	9 x 36 x 18		0 001 510 001-003,005,008-010,017-028, 030-036,038-040	
	0 001 371 004-010,012-20 9 000 453 064,65,68			QB(R) 9.0 kw -----	
	JE(R) 6,0 /6.7 kw		BSX 186-187	2 007 014 083	24 Volt
	Brush-Holder 2 004 336 077/078 Scania T 144 GA -----		3-BS 186	2 004 320 176	12 x 40 x 27
BSX 178-179	2 007 014 080	12 Volt	1-BS 187	2 004 320 177	12 x 40 x 27
2-BS 178	2 004 320 240	12 x 36 x 19		0 001 510 029,037	
2-BS 179	2 004 320 241	12 x 36 x 19		QB(R) 9,0 KW -----	
	0 001 418 001-003,009,012,014,015,017		BSX 190-191	Brush-Holder 6 033 AD0 130,156,380,471 AD4 026 9 003 334 363	24 Volt
	KB(R) 3,6 KW		2-BS 190	9 003 334 359, 6 033 AD4 030	6,4 x 25 x 15.4/16.4
	Replacment for BSX 130 (R) cw -----		2-BS 191	9 003 334 360, 6 033 AD4 029	6,4 x 25 x 15.4/16.4
				Stator-Frame: 6 033 AD0 151,189,473 AD4 093,098,108	
BSX 180-181	2 007 014 081	12 Volt		0 001 231 001-14,16-19,23 024,26-30,32,33	
2-BS 180	2 004 320 242	12 x 36 x 19		EV(R) 4.0 kw HE95-M 24V	
2-BS 181	2 004 320 243	12 x 36 x 19			
	0 001 418 016				
	KB(L) 3,6 KW				
	Replacement for BSX 130 (L) a/c -----				
BSX 182-183	Brush-Holder: 1 004 336 863	12 Volt			
2-BS 182	1 004 320 161	6 x 20 x 13/14.5			
2-BS 183	1 004 320 162	6 x 20 x 13/14.5			
	0 001 124 018,019				
	DB(L) 1,8 kw				
	VW Lupo/Audi A2 1.2i TDI 3L				



BOSCH Starter

BSX 192-193	Brush-Holder: 6 033 AD0 014,159-161,221,368 401,407,409	12 Volt	BSX 200-201	Brush-Holder: 1 004 336 878,884,885,891,893,895	12 Volt
2-BS 192	6 033 AD0 011,6 033 AD1 158	6 x 22 x 13 / 15	2-BS 200	1 004 320 175,210	6 x 18 x 12.7/14.2
2-BS 193	6 033 AD0 012,6 003 AD1 159	6 x 22 x 13 / 15	2-BS 201	1 004 320 176,211	6 x 18 x 12.7/14.2
	Stator-Frame: 6 033 AD0 162,164,223,225,412 AD1 108-110 AD2 002			0 001 124 001,002 125 007,08,43,48,49,51,52	
	0 001 223 001-14,16,18,19,21 500-507 EV(R) 2,3 / 2,6 KW -----			DB(L)1.8/2.0 VW overload protection starter Flex section 2.5 qmm -----	
BSX 194-195	Brush-Holder: 6 033 AD0 166,370,374, AD3 022,042 9 003 334 368	12 Volt	BSX 202-203	Brush-Holder 6 033 AD0 266,384 AD6 098	24 Volt
	Stator-Frame: 6 033 AD0 167,170,244 AD4 043,132,149,151,191		2-BS 202	6 033 AD0 263	9 x 32 x 23
2-BS 194	9 003 334 361,6 033 AD3 196	7,5 x 27 x 15,4/16,4	2-BS 203	6 033 AD0 264	9 x 32 x 23
2-BS 195	9 003 334 362,6 033 AD3 197	7,5 x 27 x 15,4/16,4		0 001 330 001,003-008	
	0 001 230 001-16,18,20,22-24,26			GVB(R)6.0 kw HEF109-M MAN, Scania, Volvo -----	
	EV(R) 3.0 KW HE95-M 12V(R) -----		BSX 204-205	Brush-Holder 1 004 336 879	12 Volt
BSX 196	Brush-Holder: 1 004 336 822,838,854,856,861	12 Volt	2-BS 204	1 004 320 177,212	4.6x10x12.0/12.7
4-BS 196	1 004 320 158	5 x 8.5 x 10.5/11.5	2-BS 205	1 004 320 178,213	4.6x10x12.0/12.7
	0 001 116 001,003-006,008,009			0 001 120 400-411 DWB(L) 0.9 kw RF70-S25(L)	
	DM(R/L) 0.7 kw -----			Audi, SEAT, Skoda, VW -----	
BSX 197	2 007 014 072	12 Volt	BSX 206-207	Brush-Holder	24 Volt
4-BS 197	2 004 320 270	9 x 36 x 18	2-BS 206	6 033 AD5 097,126	6.35x27.77x18
	0 001 370 001-004 9 000 453 029,066,067		2-BS 207	6 033 AD5 098,127	6.35x27.77x18
	Brush-Holder 2 004 336 079 JE(R) 5.0kw -----			0 001 241 001,003-005 HEF95-L 5.5kw	
BSX 198-199	Brush-Holder: 2 004 336 064	24 Volt		DAF, Scania -----	
2-BS 198	2 004 320 163	8 x 25 x 13	BSX 208-209	Brush-Holder 1 004 336 713	12 Volt
2-BS 199	2 004 320 164	8 x 25 x 13	2-BS 208	1 004 320 208	6x18x14.2/15.7
	0 001 368 083 Replacement for BSX 135-145 2 007 014 063 JF 4,0 KW		2-BS 209	1 004 320 209 flex section 2.5 qmm	6x18x14.2/15.7
				0 001 124 026,027 RF78-L35(L)	
				Audi A2 1.2TDI 3L Start/Stop VW Lupo 1.2TDI 3L Start/Stop -----	
			BSX 210-211	Brush-Holder 1 004 336 708,768,769, 785,886	12 Volt
			2-BS 210	1 004 320 179,202	4.6x16x11.5/12.2
			2-BS 211	1 004 320 180,203 flex section 2.5 qmm	4.6x16x11.5/12.2
				0 001 108 400-404 DW(R)1.4 kw R70-L25(R) RF70-L25(L)	



BS 212
BS 215



BS 213
BS 214

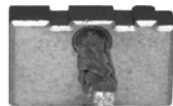

BS 206
BS 216

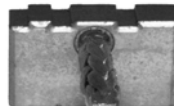

BS 207
BS 217











BS 218



BS 219

BOSCH Starter

BSX 212-213	Brush-Holder 1 004 336 712,753,770, 771,773,782,788, 888,889,898	12 Volt
		
2-BS 212	1 004 320 183,204,206	5x16x11.5/13
2-BS 213	1 004 320 184,205,207 flex section 2.5 qmm	5x16x11.5/13
	0 001 108 200-204,206-209, 211-214,217,218	
	DW(R/L) 1.4-1.8 kw R74-L10(L) R74-L45,-L60,-L75(R)	
	Alfa 147, 156 1.9JTD FIAT Marea, Marengo,Multipla,Palio,Punto, Stilo,Strada 1.9JTD Lancia Lybra 1.9JTD BMW 545i,645Ci Coupe, X5 4.4i -----	
BSX 214-215	Brush-Holder 1 004 336 743,754,755, 758,759,761,793,796,798 890,892,897	12 Volt
		
2-BS 214	1 004 320 228,234	6x18x11.0/12.5
2-BS 215	1 004 320 229,235 flex section 2.5 qmm	6x18x11.0/12.5
	0 001 115 016,17,22,23,31,32 123 02-05,12-15,18-21 DB/DW(L/R) 1.7/2.0 kw R74-E25(R) RF74-E25(L)	
	Audi A3 2.5TDI VW Golf V 1.9-2.0 TDI, Touareg 3.2, Touran 2.0 TDI -----	
BSX 216-217	Brush-Holder 6 033 AD5 179	24 Volt
		
2-BS 216	6 033 AD5 177	5.35x27.77x18
2-BS 217	6 033 AD5 178	5.35x27.77x18
	HEF95-L -----	
BSX 218-219	Brush Holder 1 004 336 765,766,786,795	12 Volt
		
2-BS 218	1 004 320 230	5x12x10.9/11.6
2-BS 219	1 004 320 231 flex section 2.0 qmm	5x12x10.9/11.6
	0 001 107 103-106 121 024-031 DB/DW(L/R) 1.2 kw R/RF74-M40(R) RF74-M50(L)	

BSX 220-221	Brush-Holder 1 004 336 784,790	12 Volt
2-BS 220	1 004 320 232	6x18x14.2/15.7
2-BS 221	1 004 320 233 flex section 4.0 qmm	6x18x14.2/15.7
	0 001 109 265	



Achtung! Zweistoffkohlen
siehe Einbauanleitung auf Seite 53

Attention! 2-component brushes
see assembly instructions on page 53

Komplette **Bürstenhalter** finden Sie in unserem
Katalog **ERSATZTEILE FÜR STARTER UND
LICHTMASCHINEN**

For complete **BRUSH-HOLDERS** see our
catalogue **SPARE PARTS FOR STARTERS AND
ALTERNATORS**

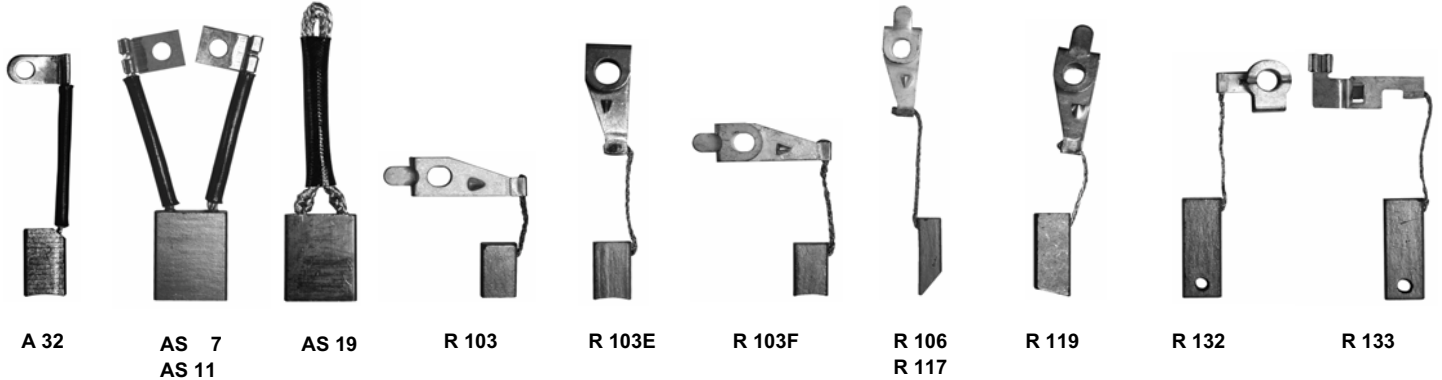

C.A.V.	Alternator	Starter	DELCO-REMY	Alternator
AX 32	6067-69		RX 103	1971521 12 Volt
2-A 32	6019-372 AC7A24,AC7B24-212 -----	7,9 x 6,3 x 13,5	2-R 103	1942360, 1971523 10 SI,27SI ----- 8 x 5 x 13,2
ASX 7	6068-2	24/32 Volt	RX 103 E	Brush-Box 7982589 12 Volt
4-AS 7	5586-12A BS524,BS532 -----	9 x 20 x 26	2-R 103 E	7 982 543 7982574,75 7982600,1,4,5,48,52,74,75,98,99 7982703-5,7,10,17,20,21,28,38-45, 47-53,58,59,62,63,66,78,87, 7982811,12,22,54,56,57,64,65,72-75,80 7982952,53,80,81,86,88 ----- 8 x 5 x 13,2
ASX 11	6068-8,6068-28	12 Volt	RX 103 F	Brush-Box 3472316,19 DR701 12 Volt
4-AS 11	6211-67,5933-337 CA4512,CA45C12,CA45LC12,CA45D12 -----	9 x 20 x 26	2-R 103 F	DR 702 34 72 002,4,8,14,18,22-24,26-28,32,33, 035,37,38,42,48-53,57-62,65-68 Opel ----- 8 x 5 x 13,2
ASX 19	6068-34,-18	12 Volt	RX 106	12 Volt
4-AS 19	6211-410,5933-530 CA4512,CA45C12,CA45LC12, CA45D12,CA45F12	9 x 20 x 26	2-R106	187 6873 27 SI 200 ----- 8 x 5 x 24
			RX 117	1995564 Brush Box 1894559 12/24 Volt
			2-R117	10467935, 10499511 1894564 10 SI 116,136 15 SI 116 ----- 6 x 5 x 22
			RX 119	Brush-Box 1988986 12 Volt
			2-R119	17 SI all units ----- 8 x 5 x 21
			RX 132-133	Brush-Box 1989651 12 Volt
			1-R132	1989661 8 x 5 x 22,5
			1-R133	1989660 8 x 5 x 22,5
				CS 121,130 1101196,1199,1551 3472171 Opel, Renault

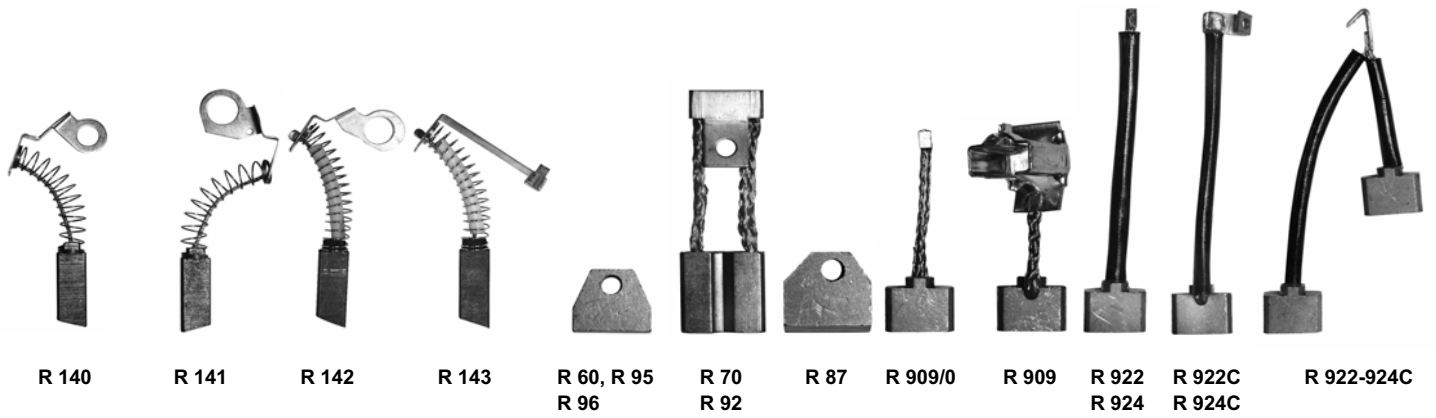

DELCO-REMY Alternator Starter

RX 140-141	Brush-Box 10475746	12 Volt	RX 120 (2)	3471506 (DR 751)	12 Volt
1-R140		8 x 4,5 x 22	1-R 909	3471487	6 x 16 x 14
1-R141		8 x 4,5 x 22	1-R 924 C	3471488 w. clip	6 x 16 x 14
	CS 130D latest model 10479214,15 9981,84 10480052,71,187-190			3471143	
	Opel, Chevrolet, Saab, Vauxhall -----		RX 120/0 (2)	3471625	12 Volt
RX 142-143	Brush-Box 10475011	12 Volt	1-R 909/0	3471009 w/o. Brush-Holder	6 x 16 x 14
1-R142		8 x 4,5 x 22	1-R 924	3471024	6 x 16 x 14
1-R143		8 x 4,5 x 22		3471150	
	CS 130D 10479914,23,47,55 3493947		RX 120 (3)	3471764 w. Brush Holder	12 Volt
	Opel, Chevrolet, Saab, Vauxhall -----		1-R 909	3471009 / 3471487	6 x 16 x 14
RX 60		12 Volt	1-R 922C	3471022 w. clip	6 x 16 x 14
4-R 60	1906945,966 (D757) 1946400(D760)	6,3 x 19,05 x 16	1-R 924C	3471024 w. clip	6 x 16 x 14
	1107201,1107619-895, 1108284,1108300-8307,8390,9439 199829 5 MT,8MT,10MT,SD300 Hyster Stapler -----		RX 120/0 (3)	3471764	12 Volt
RX 70 (4)		24 Volt	1-R 909/0	3471009 w/o. Brush-Holder	6 x 16 x 14
4-R 70	1906986 1946407,483	9,5 x 19,05 x 19	1-R 922	3471022	6 x 16 x 14
	40 MT (2 Sets) -----		1-R 924	3471024	6 x 16 x 14
RX 87		12 Volt		3471169	
4-R 87	1906958,962,968,987 (D757,D759,D761)	9,5 x 19,05 x 19	RX 120 (4)	3471505 (DR 700)	12 Volt
	30 MT,35 MT -----		2-R 909	3471009	6 x 16 x 14
RX 92		24 Volt	1-R 922-924 C	3471022 + 3471024 w. clip	6 x 16 x 14
4-R 92	1906918,989 1946426,487 1109961-98	7,9 x 19,05 x 19		3471141,144	
	50 MT (3 Sets) -----		RX 120/0 (4)	3471783,3471834	12 Volt
RX 95		6/12 Volt	2-R 909/0	3471009 w/o. Brush-Holder	6 x 16 x 14
4-R 95	1946434,1976861	9,5 x 19,05 x 19	1-R 922	3471022	6 x 16 x 14
	1107506-88 20MT,25 MT Clark Stapler -----		1-R 924	3471024	6 x 16 x 14
RX 96	(R120)	12 Volt		3471155,169,170,173-176	
4-R 96	1852880 (D764)	7,9 x 19,05 x 19	RX 120 (2) S	-----	12 Volt
	22MT,27MT		1-R 909/0	3471009 w/o. Brush-Holder	6 x 16 x 14
			1-R 924 C	3471024 w. clip	6 x 16 x 14
			1-R 924 C	3471024 w. clip	6 x 16 x 14
			RX 120 (3) S	-----	12 Volt
			1-R 909/0	3471009 w/o. Brush-Holder	6 x 16 x 14
			1-R 922 C	3471022 w. clip	6 x 16 x 14
			1-R 924 C	3471024 w. clip	6 x 16 x 14
			RX 120 (4) S	-----	12 Volt
			2-R 909/0	3471009 w/o. Brush-Holder	6 x 16 x 14
			1-R 922-924 C	3471022 + 3471024 w. clip	6 x 16 x 14
			RX 121 (4)	-----	12 Volt
			2-R 909	3471009 / 3471487	6 x 16 x 14
			1-R 922 C	3471022 w. clip	6 x 16 x 14
			1-R 924 C	3471024 w. clip	6 x 16 x 14



R 122
R 122H



R 124
R 124H



R 134
R 134H



R 135
R 135H



R 419
R 458



R 420
R 457



R 911
R 912

DELCO-REMY Starter

RX 122		12 Volt	RX 419-420		24 Volt
4-R122	1852884 40 MT 400,450 -----	9,5 x 38,1 x 21,4	2-R 419	10457119	7,9 x 24,8 x 19,5
RX 122 H		24 Volt	2-R 420	10457120	7,9 x 24,8 x 19,5
4-R122 H	1852883 40 MT 400,450 -----	9,5 x 38,1 x 21,4		10479600,05,08,11,12 1113272,77,91 28 MT -----	
RX 124		12 Volt	RX 457-458		12 Volt
6-R124	1852887 50 MT 400 -----	7,9 x 38,1 x 20,6	2-R 457	10456457	7,9 x 24,8 x 19,5
RX 124 H		24 Volt	2-R 458	10456458	7,9 x 24,8 x 19,5
6-R124 H	1852888 50 MT 400 1114683,84,86,89 -----	7,9 x 38,1 x 20,6		1113273-82,86-88,90 292,95-97 323-451 28 MT Clark,Hyster,MF -----	
RX 134		12 Volt	RX 911	(R138)	12 Volt
4-R134	1852892 42MT -----	10,5 x 36,6 x 24,4	4-R 911	1852898	5,5 x 15 x 14,5
RX 134 H		24 Volt		9000751,56,58 PG 100 Opel Unit-Nos. 21020892,21021648 -----	
4-R134 H	1852894 42MT -----	10,5 x 36,6 x 24,4	RX 912	(R139)	12 Volt
RX 135		12 Volt	4-R 912	10499524	6 x 16 x 19
4-R135	1852889 37 MT, 41MT -----	9,5 x 28,6 x 26,3		Brush-Holder 10475602 9000786,798,804-806,812,819,822 827,834,835,850,851,853, 860-867,899,900 PG 260M	
RX 135 H		24 Volt			
4-R135 H	1852893 37 MT, 41MT	9,5 x 28,6 x 26,3			



JAA 5
JAA 8



JAA 9



JAA 10



JAA 28



JAA 33



JAA 35



JAA 38

DENSO Alternator

JAAX 5-8

		12 Volt
1-JAA 5	21660-040/060	10 x 5 x 20/18,5
	21660-090/160	
1-JAA 8	21660-050/080	10 x 5 x 20/18,5
	21660-100/170	
Hino	6-303-3106-90 6-303-3107-0	
Isuzu	9-8221-1692-0/-1693-0 9-8221-2114-0/-2115-0 9-8221-2138-0/-2139-0	
Toyota	27371-30010/-46030 27371-50020/-77010 27377-30010/-31010 27377-46030/-77010	

JAAX 9

		12 Volt
2-JAA 9	21660-0130	8 x 5 x 18/16,5
Daihatsu	27371-31011/-87202	
Hino	27371-1010 2737B-31011/-87202 6-303-3114-20	
Honda	31105-611-005 31144-516-004	
Isuzu	9-8221-1891-0/-1791-0 9-8221-2124-0	
Mazda	0727-24-542 1304-24-542	
Mitsubishi	K437128-1 MD604018 ME021981	
Subaru	39511-0802	
Suzuki	31631-31011/-55011	
Toyota	27371-31011	

JAAX 10

		12 Volt
2-JAA 10	21660-0320	5 x 8 x 17,6
Honda	31144-671-004	

JAAX 28

		12 Volt
2-JAA 28	21660-0330	8 x 5 x 22,5/20,3
Caterpillar		
Daihatsu	27371-44070	
Toyota	27371-44070	

JAAX 33

		12 Volt
2-JAA 33	21660-0311 21660-0530	8 x 5 x 28,5/26
Daihatsu	27371-56070-000 27371-87701-000 021660-0530	
Hino	27371-1160A 2737B-56070	
Isuzu	5-81215-018-0	
Mazda	V101-24-542	
Mitsubishi	ME702997	
Toyota	27371-54412 27371-56070 27371-56071	

JAAX 35

		12 Volt
2-JAA 35	21660-0390 21660-0510	7 x 5 x 15
Daihatsu	27370-87302-000 27371-63020-000 27371-87501-000 27371-70300-000	
GM	94123056 96054118	
Hino	021660-0390 021660-0510	
Honda	31144-PD1-0040 31144-PD1-0030 31150-PR7-AO1 31150-PTO-003	
Isuzu	8-94123-056-0 8-94139-014-1 8-97032-308-0 8-97032-310-0	
Komatsu	021660-0390 021660-0510	
Mazda	021660-0390 021660-0510 KL47-18-W75	
Mitsubishi	MD604474	
Subaru	021660-0510 021660-0390	
Suzuki	021660-0510 31631-82610 31656-82611 021660-0510	
Toyota	27370-42010 27370-75060 27371-63020 27371-70300 27371-72161 27372-63020	

JAAX 38

		12 Volt
2-JAA 38	21660-0370	8 x 5 x 22/19,5
Toyota	27371-44070 27371-44071	

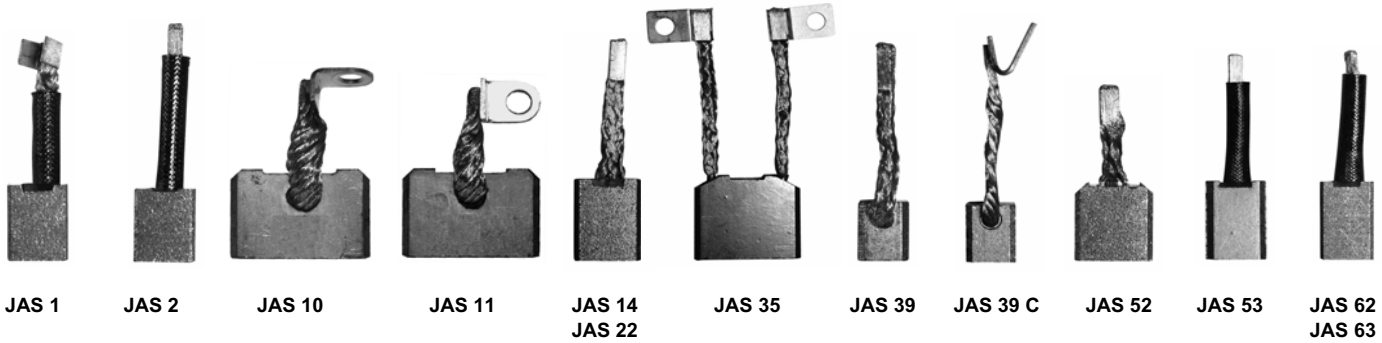

DENSO Starter

<table border="0" style="width: 100%;"> <tr> <td style="width: 15%;">JASX 1</td> <td style="width: 60%;">Denso</td> <td style="width: 25%; text-align: right;">12 Volt</td> </tr> <tr> <td>2-JAS 1</td> <td>028530-0932,1020,1030</td> <td style="text-align: right;">6 x 9 x 12,5</td> </tr> <tr> <td></td> <td>028000-8411,9133,9872,9882 128000-1431,4461,4590</td> <td></td> </tr> <tr> <td></td> <td>Motorcycle</td> <td></td> </tr> <tr> <td></td> <td>-----</td> <td></td> </tr> <tr> <td>JASX 2</td> <td></td> <td style="text-align: right;">12 Volt</td> </tr> <tr> <td>2-JAS 2</td> <td></td> <td style="text-align: right;">5 x 10 x 12,5</td> </tr> <tr> <td></td> <td>Motorcycle</td> <td></td> </tr> <tr> <td></td> <td>-----</td> <td></td> </tr> <tr> <td>JASX 10-11</td> <td></td> <td style="text-align: right;">12 Volt</td> </tr> <tr> <td>2-JAS 10</td> <td>028520-1090</td> <td style="text-align: right;">10 x 30 x 20</td> </tr> <tr> <td>2-JAS 11</td> <td>028530-1100</td> <td style="text-align: right;">10 x 30 x 20</td> </tr> <tr> <td></td> <td>Isuzu 1-8116-048-0 1-8116-049-0</td> <td></td> </tr> <tr> <td></td> <td>Denso 3.0/5.5 kw OSGR-Starter</td> <td></td> </tr> <tr> <td></td> <td>128000-049,245,247,256,274,422, 468,491,537,551,562,572,573 228000-331,332,573,585,700</td> <td></td> </tr> <tr> <td></td> <td>-----</td> <td></td> </tr> <tr> <td>JASX 14</td> <td></td> <td style="text-align: right;">12 Volt</td> </tr> <tr> <td>4-JAS 14</td> <td>28531-0110</td> <td style="text-align: right;">7 x 12 x 16</td> </tr> <tr> <td></td> <td>Daihatsu 28142-21010 Isuzu 9-8211-1649-0 Mazda 0180-23-756 Mitsubishi K437 450-0 MD604067 Subaru 89207-8602/49206/7202 Suzuki 31131-75011 Toyota 28142-21010</td> <td></td> </tr> <tr> <td></td> <td>-----</td> <td></td> </tr> <tr> <td>JASX 22</td> <td></td> <td style="text-align: right;">12 Volt</td> </tr> <tr> <td>4-JAS 22</td> <td>28531-0300</td> <td style="text-align: right;">7 x 12 x 19</td> </tr> <tr> <td></td> <td>Daihatsu 28142-10011 Mazda 0208-23-756 Mitsubishi MD604240 Subaru 89206-4102,6102/49243-7302 89206-8702,8602 Suzuki 31131-55010,-55011,-75110 31173-63210 Toyota 28142-10011</td> <td></td> </tr> <tr> <td></td> <td>-----</td> <td></td> </tr> <tr> <td>JASX 35</td> <td></td> <td style="text-align: right;">12 Volt</td> </tr> <tr> <td>4-JAS 35</td> <td>28530-0480</td> <td style="text-align: right;">9 x 30 x 26</td> </tr> <tr> <td></td> <td>J. Deere R50927 Mitsubishi MD604256/MF022002 Toyota 28142-47021/-76010/-77040</td> <td></td> </tr> </table>	JASX 1	Denso	12 Volt	2-JAS 1	028530-0932,1020,1030	6 x 9 x 12,5		028000-8411,9133,9872,9882 128000-1431,4461,4590			Motorcycle			-----		JASX 2		12 Volt	2-JAS 2		5 x 10 x 12,5		Motorcycle			-----		JASX 10-11		12 Volt	2-JAS 10	028520-1090	10 x 30 x 20	2-JAS 11	028530-1100	10 x 30 x 20		Isuzu 1-8116-048-0 1-8116-049-0			Denso 3.0/5.5 kw OSGR-Starter			128000-049,245,247,256,274,422, 468,491,537,551,562,572,573 228000-331,332,573,585,700			-----		JASX 14		12 Volt	4-JAS 14	28531-0110	7 x 12 x 16		Daihatsu 28142-21010 Isuzu 9-8211-1649-0 Mazda 0180-23-756 Mitsubishi K437 450-0 MD604067 Subaru 89207-8602/49206/7202 Suzuki 31131-75011 Toyota 28142-21010			-----		JASX 22		12 Volt	4-JAS 22	28531-0300	7 x 12 x 19		Daihatsu 28142-10011 Mazda 0208-23-756 Mitsubishi MD604240 Subaru 89206-4102,6102/49243-7302 89206-8702,8602 Suzuki 31131-55010,-55011,-75110 31173-63210 Toyota 28142-10011			-----		JASX 35		12 Volt	4-JAS 35	28530-0480	9 x 30 x 26		J. Deere R50927 Mitsubishi MD604256/MF022002 Toyota 28142-47021/-76010/-77040	
JASX 1	Denso	12 Volt																																																																															
2-JAS 1	028530-0932,1020,1030	6 x 9 x 12,5																																																																															
	028000-8411,9133,9872,9882 128000-1431,4461,4590																																																																																
	Motorcycle																																																																																

JASX 2		12 Volt																																																																															
2-JAS 2		5 x 10 x 12,5																																																																															
	Motorcycle																																																																																

JASX 10-11		12 Volt																																																																															
2-JAS 10	028520-1090	10 x 30 x 20																																																																															
2-JAS 11	028530-1100	10 x 30 x 20																																																																															
	Isuzu 1-8116-048-0 1-8116-049-0																																																																																
	Denso 3.0/5.5 kw OSGR-Starter																																																																																
	128000-049,245,247,256,274,422, 468,491,537,551,562,572,573 228000-331,332,573,585,700																																																																																

JASX 14		12 Volt																																																																															
4-JAS 14	28531-0110	7 x 12 x 16																																																																															
	Daihatsu 28142-21010 Isuzu 9-8211-1649-0 Mazda 0180-23-756 Mitsubishi K437 450-0 MD604067 Subaru 89207-8602/49206/7202 Suzuki 31131-75011 Toyota 28142-21010																																																																																

JASX 22		12 Volt																																																																															
4-JAS 22	28531-0300	7 x 12 x 19																																																																															
	Daihatsu 28142-10011 Mazda 0208-23-756 Mitsubishi MD604240 Subaru 89206-4102,6102/49243-7302 89206-8702,8602 Suzuki 31131-55010,-55011,-75110 31173-63210 Toyota 28142-10011																																																																																

JASX 35		12 Volt																																																																															
4-JAS 35	28530-0480	9 x 30 x 26																																																																															
	J. Deere R50927 Mitsubishi MD604256/MF022002 Toyota 28142-47021/-76010/-77040																																																																																

 | | | | |------------------|--|----------------------| | JASX 39 | | 12 Volt | | 4-JAS 39 | 028099-5450 | 6,5 x 8 x 10 | | | Daihatsu 28142-87504-000
Honda 31211-PH9-004
Isuzu 8-94455-168-0
8-94455-167-0
Mitsubishi MD604643
Subaru 209705-5108
Suzuki 31131-51A10
Toyota 28142-10029 | | | | ----- | | | JASX 39 C | | 12 Volt | | 4-JAS 39 C | 028531-5050
with Clip | 6,5 x 8 x 10 | | | Mazda 028099-5450 | | | | ----- | | | JASX 52 | | 12 Volt | | 4-JAS 52 | 028099-6180 | 6,5 x 13 x 14 | | | Daihatsu 28142-87204-000
Isuzu 8-94377-262-0
8-94367-795-0
Mazda 028099-6180
Suzuki 31131-51A10
Toyota 28142-70020 | | | | ----- | | | JASX 53 | | 12 Volt | | 2-JAS53 | 028510-0760 | 7,5 x 13 x 18 | | | Daihatsu 28140-87703-000
Honda 31231-679-014
Isuzu 5-81119-004-0
8-94135-730-0
Subaru 49243-6002
Suzuki 31131-79010
31173-79010 | | | | ----- | | | JASX 62 | | 12 Volt | | 4-JAS 62 | 28531-0350 | 7 x 12 x 19 | | | Daihatsu 28142-25020
Honda 31211-679-004
Mazda 1345-24-753
Toyota 28142-25020 | | | | ----- | | | JASX 63 | | 12 Volt | | 4-JAS 63 | 28531-0380
28531-0480/0490 | 7 x 12 x 16 | | | Daihatsu 28142-25011/87502
Honda 31211-657-006/31231-679-004
Toyota 28142-25011 | | |



JAS 77



JAS 78



JAS 84



JAS 85



JAS 86



JAS 87



JAS 88



JAS 89

DENSO Starter

JASX 77-78

12 Volt

2-JAS 77	28531-0840	8 x 25 x 15
2-JAS 78	not insulated	8 x 25 x 15
Daihatsu	28140-54070-000 28140-64040-000 28140-87706-000	
Isuzu	5-81116-040-0 5-81118-021-0 8-94167-430-0	
Komatsu	028510-0640	
Mazda	RE01-24-750	
Toyota	28140-54070 28140-64040	

JASX 84

12 Volt

4-JAS 84	028510-0441,0580,0590,0830, -5320,5350,5420 028531-0450,0946	7 x 16 x 14
	flex length 33mm	
Daihatsu	28140-34030 -87701-000 -87704-000 -87710-000	
Honda	31208-657-0040 -657-300 -PH7-661 -PR4-0030	
Komatsu	02851-00441,-00590	
Subaru	21170-53608 23378-AA040,-AA050 49243-7212,-7302,-7502	
Toyota	28140-34030,-64130,-65020, -74010,-74020,-74070,-76070 28142-34030	

JASX 85

12 Volt

4-JAS 85	28531-0680	6,5 x 10 x 16
Daihatsu	28140-15010 28140-87201-000 28140-87502-000 28140-87702-000	
Honda	31231-PA0-0060	
Isuzu	8-94239-109-0 8-94239-110-0	
Mazda	1345-24-750 1345-24-750A 8682-24-750	
Mitsubishi	MD604916	
Subaru	23378-KA000 49206-7002 49243-7002	
Suzuki	31131-82010 31173-78310,-78311	
Toyota	28140-15010	

JASX 86-87

12 Volt

2-JAS 86	028510-0750	7 x 16 x 16
2-JAS 87	insulated	7 x 16 x 16
Daihatsu	28140-15090	
Honda	31208-PC2-661	
Toyota	28140-15090	
Unit-Nos.	128000-8320 228000-2570	

JASX 88

12 Volt

4-JAS 88	28531-0632	8 x 25 x 21
Daihatsu	28140-77090-000	
Hino	2814A-77090 28140-1220	
Isuzu	1-81119-004-0 5-81118-013-0	
Komatsu	02851-00500	
Mitsubishi	028510-0500 028510-0670	
Toyota	28142-22060/71 28140-77090	

JASX 89

12 Volt

4-JAS 89	028099-3430,3950 028510-0460,0660 028531-0720,0730	7 x 16 x 14
	flex length 22mm	
Daihatsu	28140-26070 -87707-000	
Honda	31208-657-671 -PC2-671	
Isuzu	5-81116-020-0 5-81118-022-0 8-94170-211-0 8-94317-193-0 8-94377-249-0	
Toyota	28140-26070	

DENSO MANUFACTURING ITALIA S.p.A.
see FIAT page 27



J 16

J 18

J 22

J 26

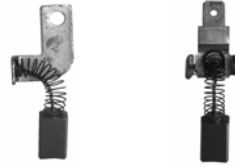

J 30, J 33

J 31



J 32

J 41/0
J 42

J 43
J 44

FIAT Dynamo / Alternator

Alternator

JX 16		12 Volt
2-J 16	4042681 (Mar.74930001) D115/12,4158027,4153104,407539, (Mar.63023312,13,15,17-19) -----	7 x 19 x 26
JX 18		12 Volt
2-J 18	4034356-74997971 DSV90 -----	6,5 x 14 x 20,5
JX 22		12 Volt
2-J 22	4110852-74996331 DSV90/12/16/3 -----	6 x 16,5 x 20,5
JX 26		12 Volt
2-J 26	4136135-74996101 D90/12/16/3E,F DC90/12/8/3 -----	6 x 16,5 x 20,5
JX 30-31		12/24 Volt
	portaspazzole 74990431	
1-J 30/J 33	4190088-74995241 4297856	8 x 5 x 16/14,5
1-J 31	4190090-74990451 A12M-124-12-42/-42B/-42M/-42X/-47/-57B A12M-124-24-26/-26D/-26M A124-14V-44A-60A A124-28V-26A 633 030 00,01,30,41,61 031 20,30,40,50,91 032 00,13,20,22,23,40,80,82,90 033 20,31,50,60,80,91 034 00,09,20,29 035 00,20,30,50,70 040 03,20,23,40,50,75,79,81-83,87,90 041 00,20 042 01,21,31 048 00,30,40,70,80,90 -----	8 x 5 x 16/14,5
JX 32	4274790-74992271	12/24 Volt
2-J 32	4274791-74992281 79703271 A108-14V-33A AA108-14V-33A -----	8 x 5 x 15,5/14,3
JX 36-37	portaspazzole 74876641 = JX 32 -----	12/24 Volt
JX 37-38	portaspazzole 74877551 = JX 32 -----	
JX 37-39	portaspazzole 74965531 = JX 32 -----	
JX 40-41/0	portaspazzole 74999891	24 Volt
1-J 40	4189862-74999901	8 x 5 x 19,5/18,3
1-J 41	4189864-74999931 A12M-124-24-26 A12MD-124-24-50 633 040 02,22 044 00,01,20,30,31,40,60,90	8 x 5 x 19,5/18,3

JX 42		12/24 Volt
2-J 42	7970502.1-7970745.1 AA125E-14V-65A AA125R-14V-45A-55A-65A-70A AA125R-28V-30A-35A 633 200 01-08,10,12,13,15-18,20-32,34,35,37,40,42, 44-58,60,63,73,82,83,91,94,96,97 201 00,02,05,10-14,18,19,21,22,26-32 210 00-11,13,15-17,19-25,27-29,31,33,35-37, 39-42,44-50,52,55,56,58-63,67,68,70-73, 77-80,82-84,86-88,90,91,95-99 211 00-14,16,17,23,26,29,36-38,41,46,49-59, 61-63,65,67-76,80,81,83,88-91,96-99 -----	7,2 x 4,2 x 17,5/16
JX 43		12 Volt
2-J 43	54202906 A 115I -14V-85A A 127 -14V-45A/55A/65A/70A A 127I -14V-85A/100A A 127IM -14V-100A A 127IR -14V-85A/100A regulator Lucas 000 28 000,001,002,006,019 regolatore Marelli 836 142 51 RTM24TR 540 220 53,54,57,58 221 30,42,47,48,60,64,67,83,86-88,95-98 222 00,12,19,24-28,32,34,36,38,41-43,51,62, 64-66,75,80,81,86,90,91,95 223 01,07,10,13,14,17,18,22,23,30,35-37,40-42, 48,49,53,74,75,77-79,82-85,88-92,94,95,97,98 224 02,08,10,15,18-20,25,26,28,31,32,36,37,39, 45-47,50,52,58,59,74,81,83,95 225 10,14,17,25,28-32,36,52,54,55,60,61,64,67, 70,72,74,75,78,80-86,88-93,95-99 226 00-04,08,11,17,21-39,41-43,46-56,62-65,68, 73-84,86,87,89,90,92-96,98 227 06 632 212 27,29,31,32,37,41,45,46,53,99 213 13,97 214 05,06,12 633 241 45,57,58,61,88,98,99 242 00,02,05,06,08,09,16,17,20,21,30,31,33,35, 40,42,45,56,57,60,62,64,71,73,74,76,77,86, 88-91,93-96,98,99 243 08,11,16,18,22,27,32,34,38,74,80,84,85,87, 90,98,99 244 00,02-04,06-09,11,18 -----	7 x 4 x 22/20
JX 44		12 Volt
2-J 44	836 225 20 A 115I -14V-55A/65A/75A/85A A 125I -14V-85A A 127IM -14V-85A/100A/120A A 127IR -14V-85A/100A AA 125R -14V-55A/65A AA 125R -28V-30A regulator Lucas 540 226 69 regolatore Marelli 836 159 21 RTM150B, -171 81 RTM153B 855 612 91 RTM151B, -620 61 633 212 00,04,05,33-35,40,52,61,70,75-78,80-83,87,92 213 00,10,11,15,16,21,28,30-33,40,43-47,49,51-55, 61,62,67,90,91,96,98 214 01,02,18,19,23,26,31,53,61,62,65,66,73 216 00-13,15-18,20,25,26,29-32,40,41,55,60,61,63,71 412 40 413 21,33,43-47,51-54 414 66 416 41,71	7 x 4 x 19/17,5



JS 5, JS 9
JS 13, JS 14
JS 16



JS 11, JS 12

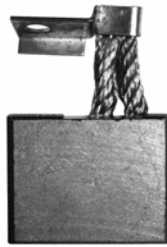

JS 15



JS 17



JS 18, JS 19

FIAT Starter

JSX 5		12 Volt	JSX 14		12 Volt
2-JS 5	748 681 71	6 x 16 x 17	4-JS 14	4005010	6,5 x 14 x 20
	B76-0,5/12S E76-0,6/12V 632 010 00-5 011 00,01 201 07,08,37,38 202 02,32 204 00,02,03,08,09,30,32,33,38,39 205 35-38			E115-1,8/12 -----	
JSX 9		24 Volt	JSX 15		24 Volt
4-JS 9	853160,747 026 10	6,5 x 14 x 20	4-JS 15	747 341 01	11,5 x 35 x 30
	E115-3/24 632 238 00,02,07,30,32			M130-7/24/M130-6/8/24V,1c,2c M130-9124T 632 243 01-03,98,99 253 01,03,91,98 263 00,02,91	
JSX 11		24 Volt	JSX 16		12 Volt
4-JS 11	4048975, 747 238 01	12 x 30 x 28	2-JS 16	748 617 81	8 x 17 x 19
	C150-7/24 632 250 00, 02,05			E84-08/12V, Var,1,2,3,6,8 632 207 00-03,05,06,20,21,23,24,30-33,35, 40,41,43,44,46 208 00-04,06,08,30,32,33,34,36 209 31,32,40	
JSX 12		24 Volt	JSX 17		24 Volt
4-JS 12	4048287, 747 132 01	10 x 20 x 25,5	4-JS 17	748 256 01	10 x 33 x 28
	C125-4/24 632 240 00, 03, 04			E125-6/24 632 241 70	
JSX 13 (4)		12 Volt	JSX 18		24 Volt
4-JS 13	748 747 41	7 x 16 x 20	4-JS 18	748 387 01	10 x 22 x 28
	E100-1,3/12, 1,5/12 632 060 02,03 223 01,04,31 224 00,05,08,09,30,35,37-39 225 01,02,31,32,35,36 227 30,31,33,35,36			M125-4/24,M3-Z9 632 245 80	
			JSX 19		12 Volt
			4-JS 19	748 460 01	10 x 22 x 28
				M125-3/12 632 24 600,02,91	



JS 21



JS 22, JS 25
JS 26, JS 27



JS 23



JS 24
JS 28



JS 29
JS 30



JS 31



JS 32



JS 33



JS 34

FIAT Starter

	(portaspazzole + bobina)				(portaspazzole + bobina)
JSX 21-22	(748 811 51 + 748 809 21)	12 Volt		JSX 29-30	(748 938 51 (855 403 51 + 748 936 31)
1-JS 21	748 809 41,512 706 52	6 x 13 x 17,5		1-JS 29	74893801,51270805
2-JS 22	748 811 21,512 70 651	6 x 13 x 17,5		1-JS 30	74893811,51270803
	E95-0,9-12				E95-0,8-12
	E95-1,0-12				E95C-0,8-12
	632 213 30,32-35,38				631 010 03
	214 30,31				632 218 30,32,34,90,92
	215 31,32,34,35,38				-----
	216 33,37			JSX 31-32	(855 403 41 + 748 941 21 + 832 228 01)
JSX 23-24-28	(748 879 51 (85540391 + 74888901)	12 Volt			12 Volt
2-JS 23	748 879 01	7 x 15,5 x 20		2-JS 31	7489438.1,51270764,74899061
1-JS 24	748 879 11	7 x 15,5 x 20		1-JS 32	7489439.1,51270765,74899071
1-JS 28	748 912 60	7 x 15,5 x 20			E95R-2,2-12
	E100-1,6/12				632 218 31
	632 232 35-39				220 30,31,34-36,38,39
	233 30-32				221 30,31,33-36,38
	-----				222 04,06
JSX 25-22	(748 811 51 + 748 883 61 + 855 303 00)	12 Volt		JSX 33-34	(832 204 61 + 832 201 31) (542 944 44 + 832 265 57)
1-JS 25	748 884 01,512 706 53	6 x 13 x 17,5			
3-JS 22	748 811 21,512 706 51	6 x 13 x 17,5		2-JS 33 (-)	832 272 58 flex 28 insul. no
	E95-1,1-12			2-JS 34 (+)	832 272 57 flex 28 insul. 35
	632 214 30				E70R-1,4-12
	215 32,38				M70R-1,4-12/-1,8-12
	-----				631 110 00,05,08
JSX 26-27	(748 911 01 + 748 909 61)	12 Volt			632 234 30-33,35,36
3-JS 26	748 910 71,512 706 61,512 707 99	6 x 13 x 17,5			235 30-33
1-JS 27	748 910 80,512 706 60,512 707 98	6 x 13 x 17,5			236 39
	E95-1,1-12				934 35
	632 214 33-36,38				
	215 30,33,36,39				
	216 30,32,35,36,39				
	217 31				

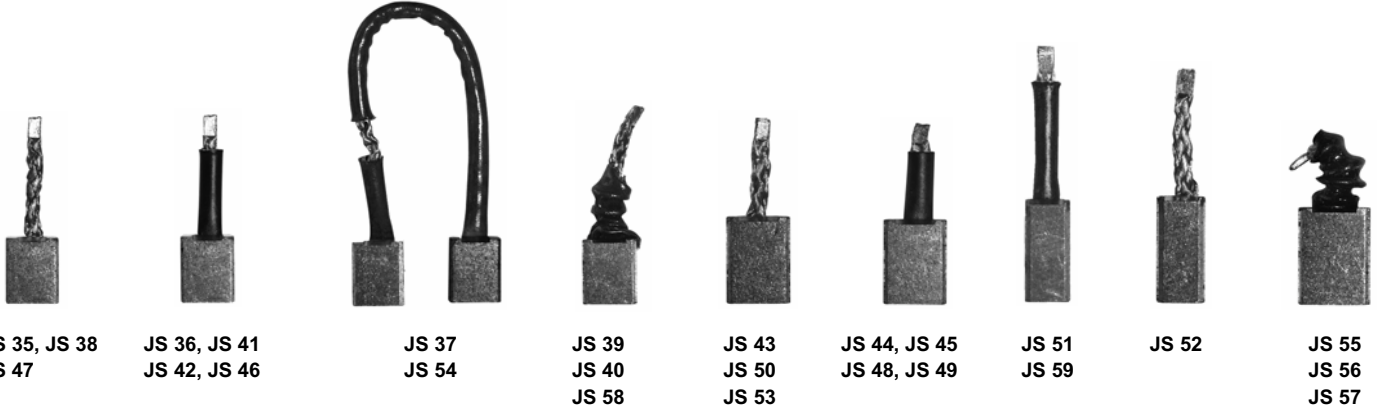

FIAT Starter

	(portaspazzole + bobina)	
JSX 35-36	(832 212 41 + 832 216 51)	12 Volt
2-JS 35	832 211 91	7 x 13 x 17,5
2-JS 36	932 212 01	7 x 13 x 17,5
	E80-0,8-12 E80-1,0-12 632 228 31-33,36-38 230 31-34	
JSX 35-37	(832 212 41 + 832 209 91 832 239 91)	12 Volt
2-JS 35	832 211 91	7 x 13 x 17,5
1-JS 37	832 216 81	7 x 13 x 17,5
	E80E-1,0-12 631 230 31-34	
JSX 38-39-40 (3)	(832 244 61 + 832 251 17)	12 Volt
1-JS 38 (-)	832 244 81 flex 26 insul. no	7 x 13 x 17,5
1-JS 39 (+)	832 274 91 flex 42 insul. 52	7 x 13 x 17,5
1-JS 40 (+)	832 274 90 flex 26 insul. 38	7 x 13 x 17,5
	E80E-0,9-12 631 020 03,04,07,08 632 229 00,01 230 85 231 01,03,08 931 03	
JSX 38-40-58 (4)	(832 253 59 + 832 257 10)	12 Volt
2-JS 38 (-)	832 244 81 flex 26 insul. no	7 x 13 x 17,5
1-JS 40 (+)	832 274 90 flex 26 insul. 38	7 x 13 x 17,5
1-JS 58 (+)	832 269 21 flex 80 insul. 100	7 x 13 x 17,5
	E80E-1,0-12 631 030 02,03,07,08	
JSX 38-41 (2)	(832 244 61 + 832 251 46 832 253 26 + 832 263 48 + 832 264 91)	12 Volt
1-JS 38 (-)	832 244 81 flex 26 insul. no	7 x 13 x 17,5
1-JS 41 (+)	832 252 66 flex 26 insul. 18	7 x 13 x 17,5
	E80E-0,8-12 631 010 00,02 632 010 08 228 89,97 229 05,08,09,36 231 04,09 232 00 233 03 931 04	
JSX 38-42 (2)		12 Volt
1-JS 38 (-)	832 244 81 flex 26 insul. no	7 x 13 x 17,5
1-JS 42 (+)	832 246 21 flex 30 insul. 25	7 x 13 x 17,5
	E80E Seat	

	(portaspazzole + bobina)	
JSX 40-46-47 (4)		12 Volt
1-JS 40 (+)	832 274 90 flex 26 insul. 38	7 x 13 x 17,5
1-JS 46 (+)	832 261 48 flex 65 insul. 57	7 x 13 x 17,5
2-JS 47 (-)	832 261 89 flex 26 insul. no	7 x 13 x 17,5
	E80E	
JSX 43-45-44 (4)		12 Volt
2-JS 43 (-)	832 258 22 flex 26 insul. no	7 x 13 x 19,5
1-JS 45 (+)	832 258 23 flex 62 insul. 50	7 x 13 x 19,5
1-JS 44 (+)	832 258 24 flex 26 insul. 18	7 x 13 x 19,5
	E80E	
JSX 43-45-57 (3)	(832 258 86 + 832 258 83 + 832 262 40)	12 Volt
1-JS 43 (-)	832 258 22 flex 26 insul. no	7 x 13 x 19,5
1-JS 45 (+)	832 258 23 flex 62 insul. 50	7 x 13 x 19,5
1-JS 57 (+)	832 274 95 flex 26 insul. 38	7 x 13 x 19,5
	E80E-0,9-12 632 230 39 233 04 930 39	
JSX 48-49-50 (3)		12 Volt
1-JS 48 (+)	832 262 17 flex 26 insul. 18	7 x 13 x 19,5
1-JS 49 (+)	832 262 18 flex 42 insul. 34	7 x 13 x 19,5
1-JS 50 (-)	832 264 28 flex 26 insul. no	7 x 13 x 19,5
	E80E	
JSX 50-55-56 (3)	(832 262 16 + 832 259 35)	12 Volt
1-JS 50 (-)	832 264 28 flex 26 insul. no	7 x 13 x 19,5
1-JS 55 (+)	832 274 94 flex 26 insul. 38	7 x 13 x 19,5
1-JS 56 (+)	832 274 93 flex 42 insul. 52	7 x 13 x 19,5
	E80E-0,9-12 631 020 00 920 00	
JSX 51-52		12 Volt
1-JS 51 (+)	832 273 62 flex 26 insul. 18	7 x 8 x 19,5
1-JS 52 (-)	832 273 64 flex 26 insul. no	7 x 8 x 19,5
	E80F-0,8-12	
JSX 51-52-59 (3)		12 Volt
1-JS 51 (+)	832 273 62 flex 26 insul. 18	7 x 8 x 19,5
1-JS 52 (-)	832 273 64 flex 26 insul. no	7 x 8 x 19,5
1-JS 59 (+)	832 274 70 flex 34 insul. 26	7 x 8 x 19,5
	E80F-0,9-12	

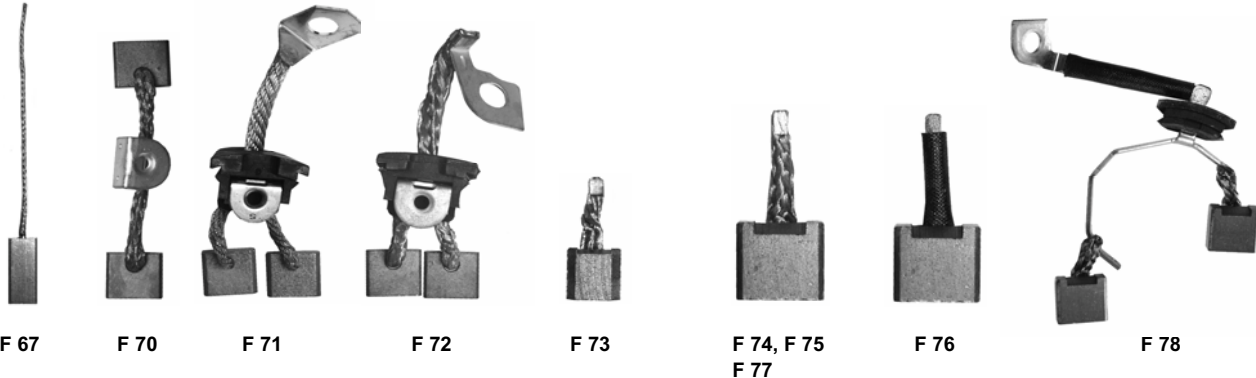

F 67

F 70

F 71

F 72

F 73

F 74, F 75
F 77

F 76

F 78

FORD Alternator Starter

FX 67	Brush-Box F1DU-10260-AA F1DZ-10347-A	12 Volt
2-F 67		7,5 x 4 x 18
	3G-series / Mondeo Diesel	

FX 70-71	Brush-Holder E90Z-11061-A,B,C	12 Volt
1-F 70 1-F 71	F0OU-11056-AA F0OU-11055-AA	4,5 x 16 x 14 4,5 x 16 x 14
	E90F-11000-AA,BA E9SF-11000-AA,BA F02F-11000-AA F07U-11000-AA,BA F0CF-11000-AA,BA F0OU-11000-AA F13U-11000-AA F17U-11000-AB F1VU-11000-AA	
	PMGR-Starter USA	

FX 70-72	Brush-Holder F3RZ-11061-A	12 Volt
1-F 70 1-F 72	F0OU-11056-AA F3RU-11055-AA	4,5 x 16 x 14 4,5 x 16 x 14
	93BB-11000-HB,JB,JC,KA,KB,KC	
	PMGR-Starter Europe	

FX 73		12 Volt
4-F 73		6 x 13 x 14
	96BB-11000-AA,AB	
	USA	

FX 74	Brush-Holder F7RU-11434-BA	12 Volt
4-F 74	F7RU-11056-AB	8,2 x 18,9 x 18,2
	97BB-11000-BB,BC 97VB-11000-AA,AB 98AB-11000-AC 98VB-11000-BA,B1A,B3A	
	Escort, Fiesta, Focus, Mondeo 1.8D 1,9 KW-Starter	



FX 74-78		12 Volt
2-F 74 1-F 78	F7RU-11056-AB F7RU-11055-AA	8,2 x 18,9 x 18,2 8,2 x 18,9 x 18,2
	same application as FX 74 but positive brush-pair with bus bar	
		

FX 75		12 Volt
4-F 75	F7RU-11056-CA TR3 97VB-11000	8,2 x 18,9 x 17,8
	Ford Transit 2,2 KW-Starter Ungarn	

FX 76-77	Brush-Holder 1C3U-11434-AA	12 Volt
2-F 76 (+) 2-F 77 (-)	1C3U-11056-BA 1C3U-11056-AA	8,2 x 18,9 x 18,2 8,2 x 18,9 x 18,2
	3,6 KW-Starter Visteon / ISKRA	



Achtung! Zweistoffkohlen
Attention! 2-component brushes

Komplette **Bürstenhalter** finden Sie in unserem Katalog **ERSATZTEILE FÜR STARTER UND LICHTMASCHINEN**

For complete **BRUSH-HOLDERS** see our catalogue **SPARE PARTS FOR STARTERS AND ALTERNATORS**



JAA 12



JAA 19



JAA 20



JAA 32



JAA 37
JAA 39

HITACHI Alternator

JAAX 12		12 Volt
2-JAA 12	L119N-1361	8 x 6 x 19
	Hino 6-403-3127-80	
	Isuzu 9-8221-2104-0	
	Nissan 23135-14800/-73500	

JAAX 19		12 Volt
2-JAA 19	L123-1326 L125-2326 L130-1327/-7326 L130-7327 L135-13261 L135-1332	7 x 6 x 16,5
	Hino 6-403-3119-90	
	Honda 31133-568-005 31134-568-005	
	Isuzu 9-8221-1609-0/-1687-0 9-8221-2105-0 9-8221-2108-0 9-8221-2120-0 9-8221-2130-0/-2131-0 9-8221-2133-0/-2149-0 9-8221-2150-0/-2151-0 9-8223-1803-0 1-33720-0630 1-33740-0130 1-33740-0150 1-33740-0270 1-33740-0280 1-81215-003-0/-006-0 5-81215-005-0/-041-0	
	Nissan 23135-16500/-16501 23135-21000/-21001 23135-21605 23135-61200 23135-65000/-65001 23135-90010 23135-90011 23135-95000	
	Subaru 89511-6101 89517-6101	

JAAX 20		12 Volt
2-JAA 20	L120-5326/-5327 L120-13262 L125-13251/-13261 L125H-1326/-1327 L130F-5326 L135-6326 L135N-1301 L150-13251/-13502/-13303 L150-73251/-73301 L160-13301/-13302 L150N-13261 L180-1335 L1401-1330	7 x 5 x 18/16,5
	Isuzu 1.81215-018-0/-021-0 5-81215-007-0/-008-0/-009-0 5-81215-012-0/-013-0/-040-0 5-81217-004-0/-009-0 5-81218-014-0 8-94361-721-0 9-8223-1617-0/-1618-0 9-8223-1604-0 9-8223-1687-0	

	Komatsu 1-337040-0450 Nissan 23133-79500 23133-C6500/-N3300/-P0100 -U0101/-U0705 23134-61500 23134-L6000 23135-01B00 23135-06800 23135-61500 23135-99000/-99001/-99004/ -99005/-99008 23135-E3200/-E3201/-N3300 -P0100/-P2500/-U0104 23142-06800 23142-20W00 23142-B9800 23142-Q4601 39526-2511 39533-2511 49526-7001/-7101/-7301 49574-7301/-7601 89511-6111 89517-6111	

JAAX 32		12 Volt
2-JAA 32	L150-23251-23252 L150-43301-83251 L150M-13251-13261 L160-33152 L225-13251,13261,23321 L240-13251,13261 L290-1325	7 x 5 x 21,5/20,5
	Isuzu 5-81215-022-0/-023-0 5-81217-023-0 8-94156-593-0 8-94223-966-0 8-97037-173-0	
	Mazda 1456-24-532/-539 S203-24-532 RF01-24-532	
	Nissan 23134-61501 23135-61501 23135-W1700 23134-Z9000 23135-Z9002 23135-99010 23142-80W00 23142-V2800/-V6600/-W1700 49574-7101	
	Subaru	

JAAX 37		12 Volt
2-JAA 37	L170-2325/-4325 L180-1325 L1110-1325	8 x 5 x 26,5/25
	Mazda 121 Nissan 23142-1P000/-19V01/-50Y05 -60U00/-64J00	

JAAX 39		12 Volt
2-JAA 39	L170-1325	8 x 5 x 18
	Isuzu 8-9446-2850-0 Nissan 23142-58S00 Subaru 23735-KA000	

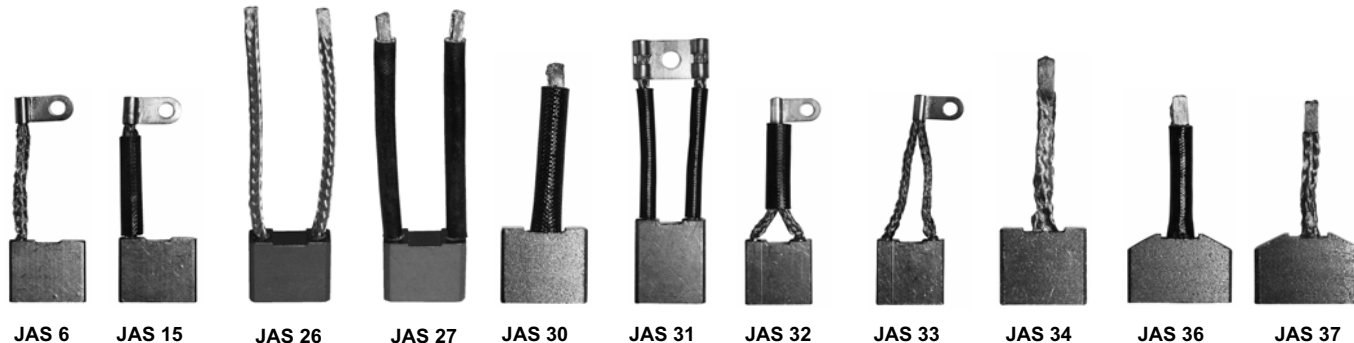

JAS 6

JAS 15

JAS 26

JAS 27

JAS 30

JAS 31

JAS 32

JAS 33

JAS 34

JAS 36

JAS 37

HITACHI Starter

JASX 15-6 (4)

12 Volt

2-JAS 15 2108-2305/-4305/-6305
2-JAS 6 2108-2306/-4306/-6306

6 x 16 x 14
6 x 16 x 14

Daihatsu 2108-2305
2108-2306
Isuzu 9-8211-16310
9-8211-16320
Nissan 23379-09900
23380-10600

JASX 26-27

24 Volt

2-JAS 26  2280-1313
2-JAS 27 2280-1312

10 x 25 x 22,5
10 x 25 x 22,5

Nissan 23331-99002
-99003

JASX 31

24 Volt

4-JAS 31 2250-1322

9 x 20 x 26

Isuzu 9-8211-1603-0
9-8211-5114-0
1-2174-0030-0
Nissan 23331-90001
23331-90004
23379-61502

JASX 32-33

12 Volt

1-JAS 32 2114-2313
1-JAS 33 2114-6312

7 x 16 x 16,5
7 x 16 x 16,5

Isuzu 9-8211-16440
9-8211-16450
Nissan 23379-19900
23380-19900

JASX 34-30

12 Volt

2-JAS 34 2130-6312
2-JAS 30 2130-9311

8 x 19 x 18
8 x 19 x 18

Isuzu 8-94028-460-0/-464-0
8-94228-440-0
8-94228-444-0
8-94228-464-0
Nissan 23379-V0700
23380-V0700

JASX 36-37

12 Volt

2-JAS 36 2130-5312
2-JAS 37 2130-8311
2250-5322
2250-5323

8 x 25 x 18
8 x 25 x 18

Isuzu 1-81116-023-0
1-81116-024-0
5-81116-024-0
5-81116-025-0
8-97030-389-0
Nissan 23379-J5500

23380-J5500
23331-Z9002
23331-Z9003
28331-Z9000
28331-Z9001



JAS 49, JAS 50
JAS 54, JAS 59



JAS 51, JAS 55
JAS 60, JAS 61



JAS 56



JAS 3



JAS 56/0, JAS 57
JAS 64 - JAS 66



JAS 3/0, JAS 58
JAS 67

HITACHI Starter

JASX 49-61

12 Volt

1-JAS 49	2114-63125	4,5 x 14 x 17
2-JAS 61	2114-43125	4,5 x 14 x 17
Brush Holder	2114-43105 / 23378-1E401 2114-53105 / 23378-50Y04 2114-63104 / 23378-1E400	

Nissan	23380-1E400 23379-1P100	
Hitachi-Starter	S114-750,-752,-753,-754A,-758, -762,-765,-766,-767,-769, -775,-780,-870	

JASX 50-51

12 Volt

1-JAS 50	2114-23124/-63121 2114-73122/-83122 2114-93122	7 x 11 x 16
----------	--	-------------

2-JAS 51	2114-83121	7 x 11 x 16
----------	------------	-------------

Mazda	B101-18X-72/-18X-66	
Nissan	23379-53J00/23380-53J00 23379-M8001/23380-12G01 23379-M8001/23380-42L60 23379-M8001/23380-57M60 23379-M8001/23380-77A01 23379-M8001/23380-M8001	
Subaru	23387-KA000 23388-KA000 49206-6401/-6501 49207-6401	
VW	Golf, Passat 1.6, Santana	

JASX 54-55

12 Volt

1-JAS 54	2114-63126	4,5 x 14 x 15
2-JAS 55	2114-53126	4,5 x 14 x 15

Brush Holder	2114-23106 2114-73105	OPEL Astra D OPEL Corsa D
Hitachi-Starter	S114-808/-816 S114-800/-801/-804 -805/-818/-850	OPEL Astra D OPEL Corsa D
Nissan	23380-OM300 23379-OM300	
Opel	JHTSX 300-301	

JASX 56-3

12 Volt

2-JAS 56	2120-1311,1312	8 x 14,5 x 22
2-JAS 3	2120-4311,5312 2120-7311	8 x 14,5 x 22

Isuzu	9-8211-16510 9-8211-16520 9-8211-16460 9-8211-16470	
Nissan	23379-37500 23379-37502 23379-37503 23379-65000 23380-37500 23380-37502 23380-37503 23380-65000	

JASX 56-3/0

12 Volt

2-JAS 56/0	2120-7312	8 x 14,5 x 22
2-JAS 3/0	2120-9311 Nissan	8 x 14,5 x 22
	23379-G7000 23380-G7000	

JASX 57-58

12 Volt

2-JAS 57	2114-4313	7 x 11 x 18
2-JAS 58	2114-8312	7 x 11 x 18

Daihatsu	2114-4313/8312	
Honda	31246-568-005 31217-568-005	
Isuzu	9-8211-1657-0/1658-0	
Nissan	23379-16E01/-21000 23380-16E01/-21000	
Subaru	9402-1408/1409	

JASX 59-60

12 Volt

1-JAS 59	2114-73123	4,5 x 11 x 16
2-JAS 60	2114-83123	4,5 x 11 x 16

Nissan	23380-53J00 23379-53J00	
Subaru	23387-KA000 23388-KA000	
Hitachi-Starter	S114-556A,-558	
Nissan-Starter	23300-53J00	
Subaru-Starter	23300-KA270	

JASX 64-65-67

12 Volt

1-JAS 64	2114-59003	7 x 11 x 16
1-JAS 65	2114-93121	7 x 11 x 16
1-JAS 67	2114-83121	7 x 11 x 16

Honda	31215-634-0050/PD4-0050	
Isuzu	5-81116-056-0 5-81119-034-0 8-94208-294-0	
Nissan	23379-M0100/M0101/M0102 23380-M0101	
Subaru	49206-1001/-5501 49207-1001	

JASX 66-67

12 Volt

2-JAS 66	2114-3315/-5312	7 x 11 x 16
2-JAS 67	2114-6313/-8313	7 x 11 x 16

Honda	31215-634-0050/31216-634-0050 31215-679-0050/31216-679-0050	
Isuzu	8-94208-294-0/8-94208-300-0 5-81116-008-0/5-81116-009-0	
Nissan	23379-80W00 23379-M0100/-M0102 23380-56A00 23380-M0100/-M0101	
Subaru	21070-53908/-54008 24370-54008 49206-1001/49207-1001 49206-5501/49207-5501	



JAS 74



JAS 75



JAS 80



JAS 81



JAS 92
JAS 94



JAS 93
JAS 95

HITACHI Starter

JASX 74		12 Volt
4-JAS 74	2130-23112	7 x 19 x 15,8
	Isuzu 8-94136-900-0	
	Nissan 23380-10G00	
	23379-10G00	

JASX 74-75		12 Volt
2-JAS 74	2130-13111	7 x 19 x 15,8
2-JAS 75	2130-7312	7 x 19 x 15,8
	2240-1311/1312	
	Daihatsu 23379-W2500/23380-W2500	
	2331-T9000/T9001	
	Isuzu 5-81118-021-0	
	8-94136-900-0	
	8-94152-930-0/970-0/973-0	
	8-94242-061-0/8-94242-065-0	
	8-94478-862-0	
	Mazda 894152970/-973	
	Nissan 23379-54A00	
	23380-10G00	
	23380-54T00	
	23380-W2500	
	Volvo 740 D, 760 D	

JASX 80-81		12 Volt
2-JAS 80	2114-59002	7 x 14 x 16
2-JAS 81	2114-69002	7 x 14 x 16
	Isuzu 8-94208-440-0	
	8-94208-444-0	
	8-94228-440-0	
	8-94228-444-0	
	Nissan 23379-M4900	
	23380-M4900	
	Hitachi-Starter 5114-480	

JASX 92-93		12 Volt
2-JAS 92	2130-2312/4311	9 x 19,5 x 22
	2130-3311/1312	
2-JAS 93	2130-4312/7311	9 x 19,5 x 22
	Isuzu 5-81116-015-0	
	5-81116-016-0	
	5-81116-048-0	
	5-81116-049-0	
	8-94137-714-0	
	8-94137-716-0	
	9-8211-1551-0	
	9-8211-4151-0	
	9-8211-4152-0	
	Nissan 23379-J2000	
	23380-J2000	
	23379-61503	
	23380-61501	

JASX 94-95		24 Volt
2-JAS 94	2250-2323	9 x 19,5 x 19,5
2-JAS 95	2250-4322	9 x 19,5 x 19,5
	2250-1324	
	2120-2601	
	2130-1310	
	Isuzu 1-81116-017-0/-018-0	
	5-81116-017-0/-018-0	
	5-81119-001-0	
	5-81119-015-0	
	5-81119-016-0	
	9-82111-551-0	
	Nissan 23379-61503	
	23380-61501	
	23331-Z9000	
	23331-Z9001	
	Hino 28142-1020A	
	28142-1010A	

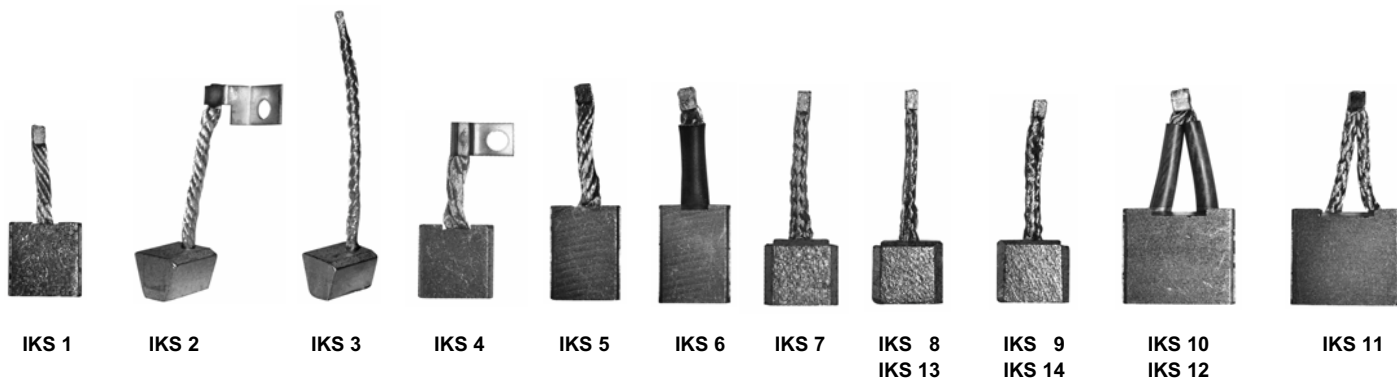

ISKRA Starter

IKSX 1	16 905 108	12 Volt
2-IKS 1		8 x 17 x 19
	AZE 0303,0304,0305,0308 3502,3504,3506,3508,3512-3514,3517,3519 11 130 007,29,34,85,102,155,162,166,217-219,234,292	
	0,6 / 0,8 KW	
IKSX 2-3	16 905 439,950	12 Volt
1-IKS 2		13,9/6,9 x 12 x 15
1-IKS 3		13,9/6,9 x 12 x 15
	AZF 3509,3512,3513,3515,3517-3519,3524,3527, 3528,3531,3533,3534,3543,3545,3547,3549,3551, 3552,3555,3558,3559,3560 11 130 193,208,210,233,244-246,291,334,338,346, 351,352,375,378,392,395,418,431,505,582, 590,600	
	0,8-1,0 KW	
IKSX 4	16 905 225	12 Volt
2-IKS 4		6 x 16 x 17
	AZD 3502,3503,3508,3511 11 130 134,143,266,314	
	0,6 KW	
IKSX 5-6	16 905 645,973	12 Volt
2-IKS 5		9 x 16 x 23,5
2-IKS 6	16 770 377	9 x 16 x 23,5
	AZJ 3105,3123,3137-3140,3144,3145,3148,3149-3151, 3155-3157,3166,3169,3170,3182,3192,3195,3197, 3198,3203-3206,3217-3219,3227,3237,3248,3249, 3255,3508,3514,3538,3554,3556,3567,3574,3581 11 130 117,123,203,250,253,300,309,319,386,432, 500-503,509,510,520,521,525,526,531-533, 548,551,552,579,612,618,620,624,629,632, 665,669,670,682,697,709,711,732	
	2,4 / 2,7 / 3,0 KW	
IKSX 7	16 770 205	12 Volt
4-IKS 7	16 770 241 mono	6 x 12 x 11,5
	same application as IKSX 8-9	
IKSX 8-9	16 905 832	12 Volt
2-IKS 8	16 770 111	6 x 12 x 11,5
2-IKS 9	16 770 110	6 x 12 x 11,5
	AZE 1501,1502,1507,1508,1515-1517,1520,1521, 1523,1526,1528,1531 11 130 321,328,398,404,483,487,495,519,529,556, 580,586,661	
	0,8 / 0,9 KW	



IKSX 10-11	16 905 695	24 Volt
2-IKS 10	16 770 376	8 x 25 x 23
2-IKS 11		8 x 25 x 23
	AZJ 3131-3133,3186,3188,3589,3593,3595 11 130 339,364,367,490-492,595,598	
	4,0 KW	
IKSX 10		24 Volt
4-IKS 10	16 770 376	8 x 25 x 23
IKSX 12	16 905 688	12 Volt
4-IKS 12	16 770 239	10 x 25 x 23
	AZJ 0402,0404,0405,3109,3110,3114-3119, 3121,3128,3158,3171,3187,3188,3190, 3516,3517,3525,3531,3534-3537,3548, 3555,3557,3582,3594,3598,3599 11 130 026,074,076,127,140,179,194,198-201, 229,251,254,322,366,373,376,402,403, 408-412,414,419,484,534,553,596,605, 611	
	3,0 KW	
IKSX 13-14	16 906 368	12 Volt
2-IKS 13	2-component	6 x 18 x 13
2-IKS 14	2-component	6 x 18 x 13
	AZE 2502,2507,2512,2521-2523,2525, 2535-2538 11 130 417,558,593,642,646,647,651, 717,722-724	
	1,4 / 1,7 KW	



Achtung! Zweistoffkohlen
Attention! 2-component brushes

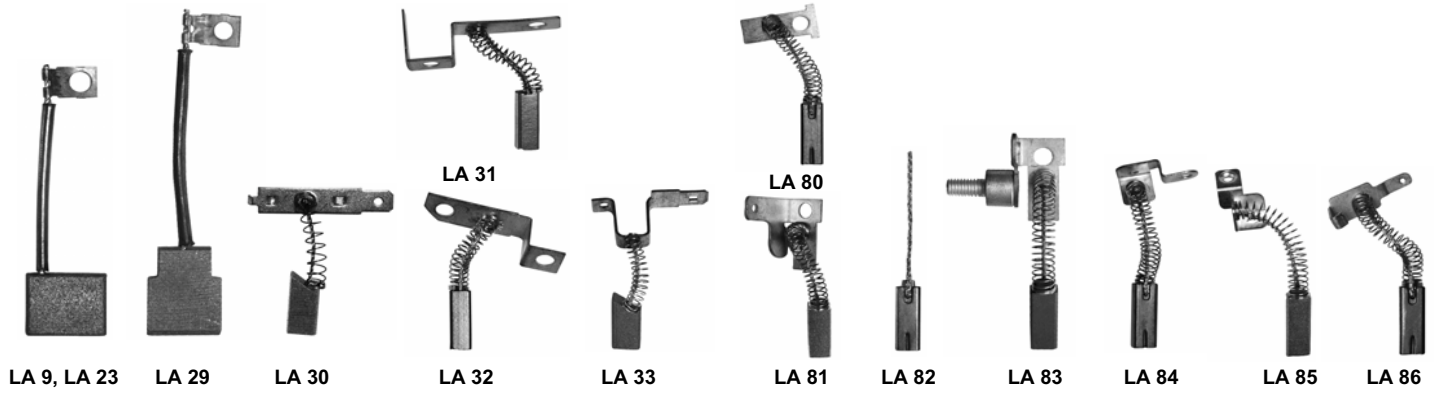

LUCAS Dynamo Alternator

LAX 9	227305 (USB 103)		LAX 33	54218506 (ULB 107)	
2-LA 9	227304,2615	6,35 x 19,05 x 15,9	2-LA 33		7,9 x 4,6 x 17,9
	C39P,PV,V,ZV,XV			11AC	
LAX 23	227541 (USB 104)			23545,79,80	
2-LA 23	229252	5,5 x 19,05 x 18,2	LAX 80-81	60600780 (ULB 105)	12 Volt
	C40PV,-1		1-LA 80		7 x 4 x 22/20
	22700,3-5,13,15,16,18,19,32,33,35,42,44,47-49, 55,57,63,65-67,71,72,75,79,80,85-91		1-LA 81	54203641	7 x 4 x 22/20
LAX 29	54216361 (USB 106)			23983-86,96-99	
2-LA 29	54214342,54	5,5 x 17,4 x 23		24020,23-28,34-38,49,51-54,58,59	
	C40-T,22762			61-72,79,82,83,85-90,94-96,98,99	
	22756,58,61,62,64,69,83,92			24112,14-19,28,31-37,44,47,49,51,53, 64-66,70,77-85,89-92	
LAX 30	54215076 (ULB 109)			24204,10,11,37	
2-LA 30	54214363	7,9 x 4,6 x 17,9	LAX 80-83	A115/133	
	10AC,11AC			60600779 (ULB 104,106, 113)	12 Volt
	23504,7,17-19,21-30,32-41,43,49,51, 53,58,77,78,88		1-LA 80		7 x 4 x 22/20
	23601		1-LA 83		7 x 4 x 22/20
	23710			23969-71	
LAX 31	54218706 (ULB 108)			24010,11,41,46,47,55,56,60,91-93	
2-LA 31		4,6 x 4,6 x 12,7		24100-02,10,25-27,29,42,46,50	
	15AC,16AC,17AC			A115, A133	
	23544,48,95		LAX 82		12 Volt
LAX 31-32	54219368 (ULB 110)		2-LA 82	54202906	7 x 4 x 22/20
1-LA 31		4,6 x 4,6 x 12,7		A127	
1-LA 32		4,6 x 4,6 x 12,7	LAX 84-85		12 Volt
	15ACR,16ACR,17ACR,18ACR		1-LA 84		7 x 4 x 22/20
	23562,63,65-70,72,73,75,76,81-85,89-93,97-99		1-LA 85		7 x 4 x 22/20
	23600,2-6,9-20,22-27,29-32,34-56,58-68,73-80, 82,85-87,90-99			A127I	
	23700-9,11-19,21-23-31,34-43,45-48,50-71, 73-86,93-99		LAX 86		12 Volt
	23800-20,22-28,30-33,35,37-57,59-65,67-69, 71-74,76-86,88-99		2-LA 86	54390877	7 x 4 x 23
	23900-58,61-64,67,68,72-74,80,87-95			A127	
	24012-19,22,29-33,44,45,48,73				
	24103,8,39,40				

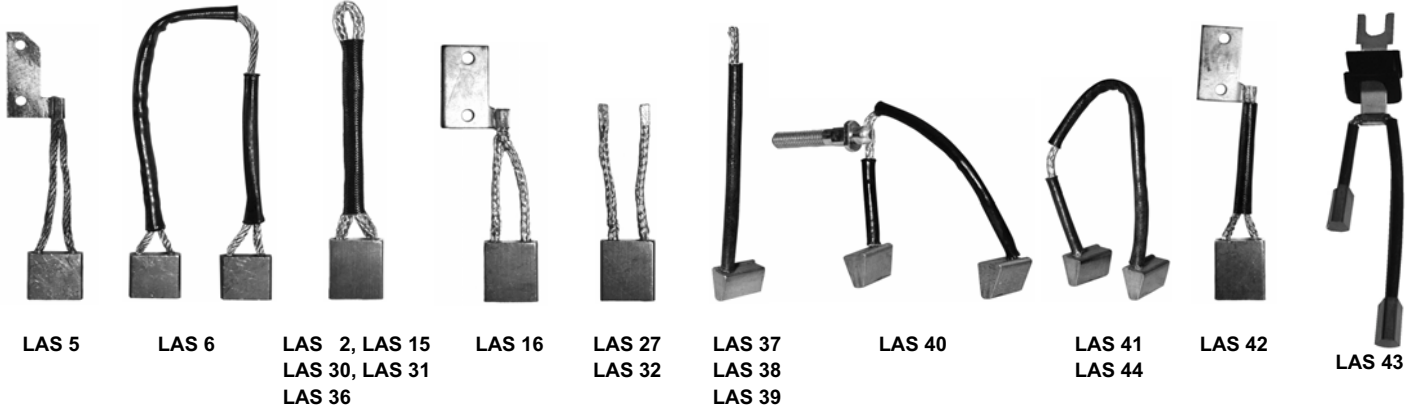

LUCAS Starter

LASX 2	255659,270005 (TAB 127)	12 Volt	LASX 36	54259517 (TAB 118) 60600849	12 Volt
2-LAS 2	263018,265426	8.8x19.05x13.5	4-LAS 36	54248210	9 x 20 x 26
	M35G/M45AL,G/M418G			M50,M127 26227,34,46,65,73,74,82,84,90,94,95,97,98 26304,5,12,16,17,23,29,36,37,41-45,49,51, 52,55,57-61,63,65,66,69,74,76,78,79,84, 86,88,89,93,98 26402-4,7-11,14,16,20,21,23,27-31,33-37	
	-----			27304 27500-9,11-16,18-28,31-34,36-41,43,45-47, 50-54,56-59,63-65	
LASX 5-6	251108 (TAB 128)	12 Volt	LASX 37-38-39	54242194 (TAB 103)	12 Volt
2-LAS 5	251103,5426	6,35 x 15,9 x 14,2	2-LAS 37	(cable 45 mm)	9,5/3,5 x 11,6 x 15,9
1-LAS 6	251165,54257344, 54258281	6,35 x 15,9 x 14,2	1-LAS 38	(cable 85 mm)	9,5/3,5 x 11,6 x 15,9
	M35G1		1-LAS 39	(cable 110 mm)	9,5/3,5 x 11,6 x 15,9
	25079,83,85,88,105,112,118,138,142			M35J	
	-----			-----	
LASX 15-16	271735 (TAB 125)	12 Volt	LASX 40-41	54244848,60600056 (TAB 117)	12 Volt
2-LAS 15	271491,5426	7,9 x 19,05 x 22,2	1-LAS 40	54265217,54266892	9,5/3,5 x 11,6 x 15,9
2-LAS 16	271493,5426	7,9 x 19,05 x 22,2	1-LAS 41	54265216	9,5/3,5 x 11,6 x 15,9
	M45G,M113			M35J,K 25137,45-50,56,57,59,65-68,78,80,82-87,90,91 25204-7,9,10,13-16,19,23,34,38,39,41,42,46,49,50, 53,55,59,62,64-66,68-74,76-84,87-92,94,98,99	
	26147,48,51,53,54,63,66,78,89,92,93,96,98 26200,1,8,15,19,20,33,36,38,48,55,56,59,64, 66-71,75,78-81,83,85-88 26300-2,6,10,20,21,46-48,64,70-73,75,81, 83,85,90,91,94,96 26400,12,13,22 27403,5,6,9-14,16-28,31-33,35,36,38-40,43, 46,47,49,52,57-59,63,65,68-70			25311,27,29,30,42,43,45-48,68,73 25400 60925019,2	
	-----			-----	
or			LASX 42	54244979	12 Volt
LASX 15-27	271735(-1) (TAB 120)	12 Volt	4-LAS 42	54258779,54262842	9 x 20 x 26
2-LAS 15	271491,5426	7,9 x 19,05 x 22,2		M50, M127	
2-LAS 27	271492,5426	7,9 x 19,05 x 22,2		-----	
	M45G(-1)		LASX 43-44	54246258 (TAB 124)	12 Volt
	-----		1-LAS 43	with terminal	10,3/4,7 x 13,3x17,5
LASX 30-31-32(4)	54256907 (TAB 106) 60600626,60600688	12 Volt	1-LAS 44	54243725	10,3/4,7 x 13,3x17,5
1-LAS 30	54258277 (cable 90 mm)	7,9 x 19,05 x 22,2		M100 25642-44,47-49,51,54,62,74,75,84-87,89,91,92,95,98 25703-7,9-12,16-22,28-32,34,35,39,42,43,49-51,54-56 27466	
1-LAS 31	54258280-7238 (cable 65 mm)	7,9 x 19,05 x 22,2	LASX 43-44/0	54246258 (TAB 124)	
2-LAS 32	54257236	7,9 x 19,05 x 22,2	2-LAS 44	54243725 w/o. terminal	10,3/4,7x13.3/17,5
	25585,25586,26209				

LASX 31	54258592 (TAB 119)	12Volt			
4-LAS 31	54257238 54258280 (cable 65 mm)	7,9 x 19,05 x 22,2			
	M50 26211,91 26338,39,95				

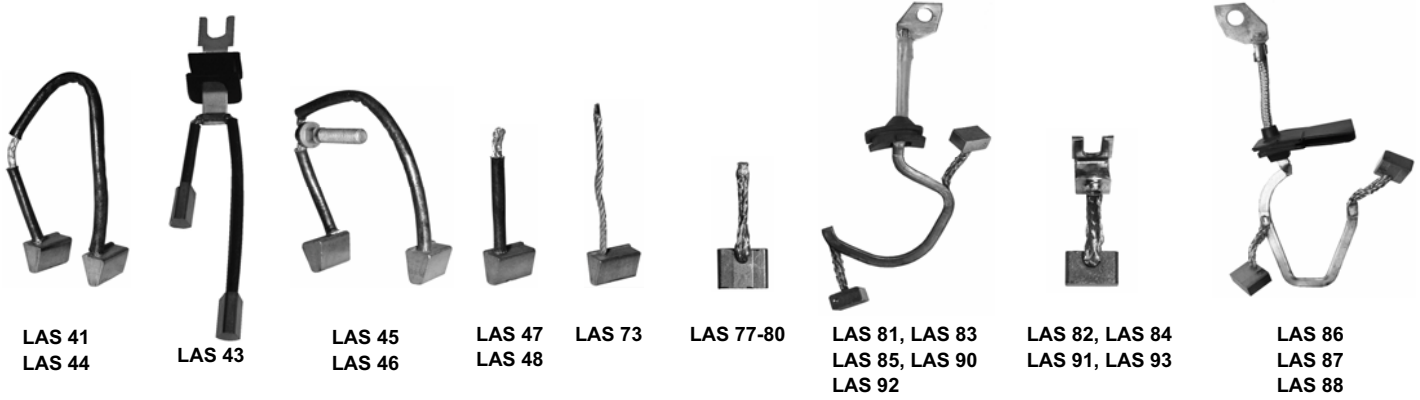

LAS 41
LAS 44

LAS 43

LAS 45
LAS 46

LAS 47
LAS 48

LAS 73





LAS 77-80

LAS 81, LAS 83
LAS 85, LAS 90
LAS 92

LAS 82, LAS 84
LAS 91, LAS 93

LAS 86
LAS 87
LAS 88

LUCAS Starter

LASX 43-47-48	60600220 (TAB 113) 60600298	12 Volt			
					
1-LAS 43		10,3/4,7 x 13,3 x 17,5			
1-LAS 47		10,3/4,7 x 13,3 x 17,5			
1-LAS 48		10,3/4,7 x 13,3 x 17,5			
	25699 25724,46,48 M 100				
LASX 44-45	60600196 (TAB 116)	12 Volt			
1-LAS 45		10,3/4,7 x 13,3 x 17,5			
1-LAS 44	54243725	10,3/4,7 x 13,3 x 17,5			
	25631,59,68,70,77-83,94,97 25700,1,45 M 100				
LASX 46-47-48	60600205 (TAB 114)	12 Volt			
1-LAS 46		10,3/4,7 x 13,3 x 17,5			
1-LAS 47		10,3/4,7 x 13,3 x 17,5			
1-LAS 48		10,3/4,7 x 13,3 x 17,5			
	25696 M 100				
LASX 73-41	60600767 (TAB 103) 9937303 FIAT	12 Volt			
1-LAS 41	54265216	9,5/3,5 x 11,6 x 15,9			
2-LAS 73		9,5/3,5 x 11,6 x 15,9			
	25326,31-33,35-40,44,49-51,54-57,59-62,65,66, 69-72,74-80,82-85,87-89,97,98 25404,5,10,11 M 90				
LASX 74-79-80	(Brushes only) = TAB 136	LASX 86-79-80			
LASX 75	(Brushes only) = TAB 133 = TAB 134 = TAB 135	LASX 83-84 LASX 85-84 LASX 81-82			
LASX 76	(Brushes only) = TAB 132 = TAB 138	LASX 92-93 LASX 90-91			
LASX 77-78-74	(Brushes only) = TAB 131 = TAB 137	LASX 87-77-78 LASX 88-77-78			
LASX 81-82	60600944 (TAB 135)	12 Volt			
1-LAS 81	bus bar assembly 54291121/24	6,8 x 13,8 x 9,4			
2-LAS 82	brush & clip assy. 54291261	6,8 x 13,8 x 9,4			
	M78R anticlock				
LASX 83-84	60600936 (TAB 133)	12 Volt			
1-LAS 83	bus bar assembly 54291119	6,8 x 13,8 x 9,4			
2-LAS 84	brush & clip assy. 54290791	6,8 x 13,8 x 9,4			
	M78R clock				
					
LASX 85-84	60600946 (TAB 134)	12 Volt			
1-LAS 85	bus bar assembly 54291050	6,8 x 13,8 x 9,4			
2-LAS 84	brush & clip assy. 54290791	6,8 x 13,8 x 9,4			
	M78R clock				
					
LASX 86-79-80	60600953 (TAB 136)	12 Volt			
1-LAS 86	bus bar assembly 54291874	7,0 x 13,7 x 12			
1-LAS 79	brush 54292331 flex 65mm	7,0 x 13,7 x 12			
1-LAS 80	brush 54291968 flex 99mm	7,0 x 13,7 x 12			
	M79 anticlock				
LASX 87-77-78	60600911 (TAB 131)	12 Volt			
1-LAS 87	bus bar assembly 54291894	7,0 x 13,7 x 12			
1-LAS 77	brush 54291966 flex 50mm	7,0 x 13,7 x 12			
1-LAS 78	brush 54291967 flex 74mm	7,0 x 13,7 x 12			
	M79 clock				
LASX 88-77-78	60600961 (TAB 137)	12 Volt			
1-LAS 88	bus bar assembly 54291873	7,0 x 13,7 x 12			
1-LAS 77	brush 54291966 flex 50mm	7,0 x 13,7 x 12			
1-LAS 78	brush 54291967 flex 74mm	7,0 x 13,7 x 12			
	M79 clock				
LASX 90-91	60600919 (TAB 138)	12 Volt			
1-LAS 90	bus bar assembly 54291003	6,8 x 19,8 x 9,4			
2-LAS 91	brush & clip assy. 54291260	6,8 x 19,8 x 9,4			
	M80R anticlock				
LASX 92-93	60600920 (TAB 132)	12 Volt			
1-LAS 92	bus bar assembly 54291002	6,8 x 19,8 x 9,4			
2-LAS 93	brush & clip assy. 54290390	6,8 x 19,8 x 9,4			
	M80R clock				
					

Achtung! Zweistoffkohlen
Attention! 2-component brushes



MAS 3



MAS 13
MAS 15



MAS 14
MAS 16



MAS 17
MAS 19



MAS 18
MAS 20



MAS 21
MAS 23



MAS 22
MAS 24



MAS 25
MAS 27



MAS 26
MAS 28

MARELLI Starter

MASX 3		24 Volt			(porta spazzole + bobina)
4-MAS 3	743 713 10,09010905	9 x 20 x 26		MASX 21-22	(721 650 01 + 721 659 01) 24 Volt
	MT31AC,43DC 632 131 27; 632 143 49			2-MAS 21	721 624 02 8 x 25 x 23
	-----			2-MAS 22	721 624 01 8 x 25 x 23
MASX 13-14		24 Volt			MT 67 AD,CB 632 167 31,41 24 V - 4,0 KW
2-MAS 13	723 632 01, 09927791	8 x 25 x 23		MASX 23-24	(721 647 01 + 721 658 01) 12 Volt
2-MAS 14	723 632 02, 09927792	8 x 25 x 23		2-MAS 23	721 624 04 10 x 25 x 23
	MT67A,AA,AB,AC,B,BA,C,CA,D,DA,DB,F,FA,FB,G,H,L 632 167 01-04,06-08,10,25-27,33,38,40,47,48,63 24 V - 4 KW			2-MAS 24	721 624 03 10 x 25 x 23
	-----				MT 68 AD,LC,MC,PA,PB,RA,S,T 632 168 17,18,31,52,61,84,96 12 V - 3,5 KW
MASX 15-16		12 Volt		MASX 25-26	(721 641 01 + 721 660 01,02 + 721 684 01) 12 Volt
2-MAS 15	723 632 03/05/07,9929080	10 x 25 x 23		2-MAS 25	721 613 02 9 x 16 x 23
2-MAS 16	723 632 04/06,9928448	10 x 25 x 23		2-MAS 26	721 613 01 9 x 16 x 23
	MT68AA,AB,B,BA,H,LA,LB,M,MA,MB,P,PA,Q,QA,R 632 168 02,8,11,14,15,16,25,26,27,33, 51,59,73,74,76,98 12 V - 3,5 KW				MT 71 AB,DB,FB,GB,HB,RB,SB,LA,TA,UA,VA MT 74 AA,BA,DA
	-----				632 171 26,48,54,56,58,63,80,86,88,97 632 174 07,08,10,25,33,47 12 V - 2,5 KW
MASX 17-18		12 Volt		MASX 27-28	(721 641 02 + 721 657 01) 24 Volt
2-MAS 17	723 837 01, 09956556, 79019316	9 x 16 x 23		2-MAS 27	721 613 04 9 x 16 x 23
2-MAS 18	723 837 02, 09956552, 79019317	9 x 16 x 23		2-MAS 28	721 613 03 9 x 16 x 23
	MT71A,D,E,FA,H,L,LA,N,R,S,T,U,V,Z 632 171 01,04-08,10,12,16-21,25,38,47,73,82 174 01-04				MT 72 AB 632 172 26 24 V - 3,0 KW

MASX 19-20		24 Volt			
2-MAS 19	723 837 03/05	9 x 16 x 23			
2-MAS 20	723 837 04/06	9 x 16 x 23			
	MT72AB 632 172 25 24 V - 3,0 KW				



JAA 15



JAA 16



JAA 24
JAA 31



JAA 25
JAA 34



JAA 36



JAA 36 ST

MITSUBISHI Alternator

JAAX 15		12 Volt
2-JAA 15	A648C01371	7 x 6 x 14,5 / 13,5
	Mazda 4002-24-552 Nissan 23135-73010	

JAAX 16		12 Volt
2-JAA 16	A648C00570	7 x 6 x 14
	Mazda 0208-24-522 2994-24-552 Mitsubishi MD602458 Nissan 23135-14610/-/21010 23135-76200/-H0110	

JAAX 24		12 Volt
2-JAA 24	A647X00771 A647X10771 A648D01071,01670 A648D01671 A648D02070,02271 A649X04070	7 x 6 x 19,5 / 18,5
	Citroen JMTX 200 Mazda 0866-24-541 1011-24-541 8028-24-541 8173-24-522 Mitsubishi MD602783 MD607373 Nissan 23135-P4510 23135-W7110 23137-Z9000 23137-Z9001 Peugeot JMTX 200 Suzuki 31631-78432	

JAAX 25		12 Volt
2-JAA 25	A648C00471 A648C01270 A648C01271 A648C01570 A648D01070 A649T02971	7 x 6 x 18 / 17
	Mazda 0290-24-556 0326-24-556 0706-24-556 0866-24-541 Mitsubishi MD602018 MD602019 MD602226 MD602750 MD602797 Nissan 23135-A5510	

JAAX 31		12 Volt
2-JAA 31	A648D01970,1971	7 x 6 x 23
	Mazda 8599-24-522 Mitsubishi ME700424 ME701186 MM502377 42752-03021 Nissan 23135-J5500 23135-W1710	

JAAX 34		12 Volt
2-JAA 34	A648C02970 A648D02570 A648D02571	8 x 5 x 18 / 16,5
	Mazda B675-18-W77 FE65-24-522 F811-18-W77 Mitsubishi MD611035 MD611566 Nissan 23135-13E10 Subaru 49574-6404	

JAAX 36		12 Volt
2-JAA 36	A648D02770 A648D03070 A990D03070	8 x 5 x 23 / 21,5
	Mazda FE2H-18-W77 JE15-18-W77 Mitsubishi MD611689 Nissan 23135-59E10 -64J12 -V5511 Renault A4T...	

JAAX 36 ST		12 Volt
2-JAA 36 ST	A647X50170 50270 50870	8 x 5 x 23 / 21,5
	with spring and terminal	



JAS 69
JAS 82

JAS 70
JAS 83

JAS 71

JAS 72

JAS 90

JAS 91

JAS 96
JAS 98

JAS 97
JAS 99

MITSUBISHI Starter

JASX 69-70(4)	Brush-Holder M649T04471 M649X03171,09571	12 Volt
2-JAS 69	M648C12170	6,8 x 11,8 x 17,2
2-JAS 70	M648C13770	6,8 x 11,8 x 17,2
	Citroen JMTSX 100 Mazda 0222-24-750/0222-24-753 0426-24-753/N202-24-750	
	Mitsubishi M001T50171 MD602468/MD602470/MD607420 M001T50171	
	Nissan 23378-N5911 23380-U0110/B5010/E3010	
	Peugeot JMTSX 100 Suzuki 31132-72030/31	
JASX 70	Brush-Holder M649T04171,04973	12 Volt
4-JAS 70	M648C13770 M648C10371B	6,8 x 11,8 x 17,2
	Mazda 0222-24-753/N202-24-750 Mitsubishi MD602069/MD607949/MM502344 Nissan 23380-E3010 23378-N5911/N5910	
JASX 71	Brush-Holder M649T02171,02172	12 Volt
4-JAS 71	M648C25671	8 x 24 x 17
	Mazda SE01-24-750 R201-18-X66 Mitsubishi MD611024 ME700858	
JASX 71-72	Brush-Holder M649T04971,4972	12 Volt
2-JAS 71	M648C25671	8 x 24 x 17
2-JAS 72	M648C25672	8 x 24 x 17
	Mazda R201-18-X66 R201-24-750 S203-24-750 SE01-24-750 Mitsubishi ME700047 ME700290 ME700939	
JASX 82-83(3)	Brush-Holder M649T01371,4871	12 Volt
1-JAS 82	M648C14970	7 x 10 x 17
2-JAS 83	M648C14870/-15070	7 x 10 x 17
	Mandoe Melroe 36173-11140 36170-2170 Brush-Holder Mazda E301-24-753 E501-24-753 Mitsubishi MD607554 MD607556 Nissan 23380-M8310 23380-M8311 Suzuki 31131-80090 31132-80090 Subaru 49206-5804 49207-5804	

JASX 82-83 (4)	Brush-Holder	12 Volt
2-JAS 82	M648C14970/-14971	7 x 10 x 17
2-JAS 83	M648C14871/-15070	7 x 10 x 17
	Mazda B630-18-X66 B660-18-X66 E301-24-750, -753	
	Mitsubishi E501-24-753 MD607554/-556 Nissan 23379-M8310 23380-M8311	
	Suzuki 31131-80090 31132-80090	
JASX 90	Brush-Holder M649T04372	12 Volt
4-JAS 90		8 x 20 x 17
	Mazda 1456-24-723 1456-24-750 Mitsubishi MD607461 Nissan 23378-W2810	
JASX 91	Brush-Holder M649T00771 flex 42 mm	12 Volt
4-JAS 91		7 x 14 x 16
	Mitsubishi M001T50172,471 Nissan Diesel Gear Starter Peugeot 205, 309 Diesel JMTSX101	
JASX 96-97	Brush-Holder M648X28671/M649T05072	24 Volt
2-JAS 96	M648C26371	6,8 x 18 x 18
2-JAS 97		6,8 x 18 x 18
	Mitsubishi ME700140/ME701169 Nissan 23330-T9000	
JASX 98-99	Brush-Holder M648X28271/M649T05071	12 Volt
2-JAS 98	M648C15372	6,8 x 18 x 18
2-JAS 99	M648C15472	6,8 x 18 x 18
	Mazda 8599-24-750 Mitsubishi MD618460 ME700127/ME701188 Nissan 23378-W3410	



JAS 24



JAS 25



PL 5



PL 10



PL 11



PLS 3



PLS 4



PLS 5

MITSUBA Starter

PAL MAGNETON Alternator Starter

JASX 24-25

12 Volt

- 1-JAS 24
- 1-JAS 25



negative brush pair
positive brush pair

4,7 x 17 x 16,5
4,7 x 17 x 16,5

186169,187387-390
D7RSA 4,8-11

Honda 31200 P45C0
Mitsuba SM402

PLX 5

12 Volt

- 2-PL 5

ID 1924

7,9 x 7,9 x 21

D 355-56; 12V/100W

PLX 10

12 Volt

- 2-PL 10

Brush-Box 443 930 132 780

6,3 x 6,3 x 15

PLX 11

12 Volt

- 2-PL 11

0131747

5 x 8 x 17

Brush-Box 443 930 166 170

443 113 516,620, 631,632,650
Skoda Favorit

PLSX 3

12 Volt

- 4-PLS 3

110-904300,02-8480-82

8 x 12 x 22

09-9142;0,7/0,8/12 10-199-4009/12

PLSX 4

12 Volt

- 4-PLS 4

93-22-32

8,8 x 26,6 x 26

PLSX 5

12 Volt

- 4-PLS 5

flex length 30mm

6 x 12,5 x 12,5

Gear Starters
443 115 141 310/311
Skoda Favorit, Felicia



U 71



U 72



U 79



U 80
U 87



U 82



U 83



U 84
U 85

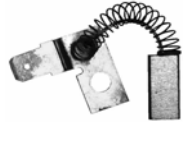

U 88



U 89



U 90, U 93a
U 95a



U 91, U 93b
U 95b

VALEO Ducellier Alternator

UX 62-73	605140 = UX 71-72 23268 -----	
UX 71-72	23268	12 Volt
1-U 71	23062	5 x 4 x 8
1-U 72	23064	5 x 4 x 8
	7522BC,32ABCDE,34ABCDE -----	
UX 79-80	608 272 (608 267,611 641) (612 430,612 386)	12 Volt
1-U 79		6 x 4,5 x 15
1-U 80		6 x 4,5 x 15
	7526C,27BC,28C,29BDEF,30B,31B,33BCD 7535B,38A,40ABC,41ABC,43AB,45A,48A,49ABCDE, 7550ABCDEF,51B,52ABCD,53AB,54A,55AB,56BC, 7557AB,58ABC,60ABC,62ABCDE,63AB,65ABCDE, 7566ABC,67ABCDE,68ABC,69ABC,70AB,71ABC,72A, 7575ABCDE,76A,77ABCDE,78ABC,79A,80ABC,81AB, 7582A,83A,84BC,85ABC,86ABCD,90ABC,91ABCD, 7593A,96ABCD,97ABCD, 512 001A,2AB,3AB 513 001A,2A,3AB,4A,5A,8ABC,9AB,10A, 515 001A,2AB,3ABC,4AB,5A, 581 003A,6A,9AB,10A,13AB,17A,89A, 618 442C,43DEF,44CD,45B,46ABCD,47BC,48AB, 618 449ABCD,50AB -----	
UX 82-83	618 306 = UX 82-83/0 -----	
UX 82-83/0	w/o. spring and terminal	12 Volt
2-U79/0-83/0	replacement for Brush-Sets UX 79-80,UX 82-83, UX 85 -----	6 x 4.5 x 15
UX 84	581 092	12 Volt
2-U 84		7 x 4 x 15
	7549G,69D,75DE,77GH,81C,84E,85D,86E,90D,97F, 512 008BCDE,10ABC 513 001C,002C,004C,005B,009D,010D,011A,12A 514 002A,4A,5BC,10A 515 003C,5B,6A,9A,10A,13A,14AB,15A,16A,18A 516 002ABC,3ABC,4AB,5A,12ABC,14A,21A,55A -----	
UX 85	581 068 = UX 82-83/0 -----	
UX 87-88	581 111 = UX 87-88/0 -----	
UX 87-88/0	w/o. spring and terminal	12 Volt
2-U 84/0-96/0	replacement for Brush-Sets UX 84, UX 87-88, UX 87-89 UX 92, UX 94, UX 96	7 x 4 x 15

UX 87-89	581 118,581 133 = UX 87-88/0 1-U 87 1-U 89 -----	
UX 90	581 154	12 Volt
2-U 90		7 x 4 x 15
	514 005DEF,7CDEF,10BCD, 516 002D,11A,19AB,27AB,32A,40BC,41BC,46A 053A,54A,55B,65A -----	
UX 90-91	581 144	12 Volt
1-U 90		7 x 4 x 15
1-U 91		7 x 4 x 15
	516 006AB,7A-9A,17A,20A,23A-25A,29A,55 581 207A,8A -----	
UX 92	581 159 = UX 87-88/0 -----	
UX 93	581 161	12 Volt
1-U 93 a		7 x 4 x 15
1-U 93 b		7 x 4 x 15
	516 013ABC,15A,16AB,50A -----	
UX 94	581 164 = UX 87-88/0 -----	
UX 95	581 216	12 Volt
1-U 95 a		7 x 4 x 15
1-U 95 b		7 x 4 x 15
	514 011ABCD,12ABCD 516 006CDE,7BCD,8BCD,9BC,17B,20BCD,23B, 516 026A,29B,30C,33A,37A-39A,42A-45A, 581 207BC,8B -----	
UX 96	581 222 = UX 87-88/0	



**US 21, US 23
US 60, US 68
US 76-78**

**US 44, US 45
US 59, US 67
US 73**

US 50

US 51

US 85

US 91

US 92

US 93

US 94

VALEO Ducellier Starter

USX 44-21	75217 (Valeo 182 194)	6 Volt	USX 67-68	79353 (618570) = USX 60-59	75238	
1-US 44	93541	8 x 15 x 15		-----		
1-US 21	93543	8 x 15 x 15	USX 73-85	618491	12 Volt	
	371A,376A,381ABCD,393A,398A,401A,426A,434A 6010ABDE,18A,60A,80B,6112ABCDE,13AB, 6120A,35ACDE,48A,67A,88A		1-US 73	(cable 41 mm)	8 x 15 x 15	
USX 45-23	75226	12 Volt	1-US 85	(618 421)	8 x 15 x 15	
1-US 45	93611	8 x 15 x 15		6020EF,35F,77BC,81EF 6134FGH,36ABD,37ABCE,39BC,44AB 6155HIKL,61ABCEFH,62ACE, 6172B,74ADBCEFGH,75AB,76EG 6181A,83ABCFG,85ABC,87CEF,89DEF, 6190AB,95A,97A, 6201ABCD,2AB,3ABCD,6AB,8AB,12AB,15ABCD, 6216ABC,17ABCDE,18A,19ABC,20ABC,21A-23A, 6224ABCD,26A,27ABCD,31ABCD,36BC,37ABCD, 6238ABCD,40A-42A,44A,45A,47AB 6627AB 532000AB,1AB,2ABC,3AB,B,4AB,C,5A,7A,8ABC 532009AB,10AB,11A,14A,17A,18A,20AB, 533000A,1A,2A,3A,4A 618074,77,91 618482,84		
1-US 23	93612	8 x 15 x 15	USX 76-77-78	618539	12 Volt	
	391A,6023A,B,C,D,E		2-US 76	22136 (cable 48 mm)	8 x 15 x 15	
USX 50-51 (2)	79325	6/12 Volt	1-US 77	22142 (cable 58 mm)	8 x 15 x 15	
1-US 50	98067,79249,680548	8,8 x 19,05 x 13	1-US 78	22143 (cable 53 mm)	8 x 15 x 15	
1-US 51	98068,79248,680549	8,8 x 19,05 x 13		6178ABCDE,6200AB,25AB,39AB, 536 001A 618 076ABC		
	350B,384A,385A,395A,396A,399AB,414AB, 422ABC,423ABC,429AB,430AB,442AB, 6002A,3A,38A,41A,43A,54AB,66A,67A,69A, 6094A,96A,6123AB,25A,56A,82A		USX 91-92	583041 (618691,692)	12 Volt	
USX 50-51(4)	618509	6/12 Volt	1-US 91	(680 752)	6/11,7 x 13 x 15	
2-US 50	98067,79249,680548	8,8 x 19,05 x 13	1-US 92	(680 753)	6/11,7 x 13 x 15	
2-US 51	98068,79248,680549	8,8 x 19,05 x 13		6202CDEF,17FGH,41B,46AC 532012AB,16AB,21A,23A,24AB,25AB,26A, 534000A,2A,3ABC,4AB,5ABC,7A,9ABC,23A,24A,29A,31A, 534032A,39A,42AB,43AB,44A-49A,50AB,51A,52A,53C,54D, 55E,57A		
	412A,428AB,429B,430B,432A,443AB 6008ABC,39A,40A,56ACDEFGHJ,62A,68A, 6070A,75A,76A,79BCD,83ABCD,85A,88A,89A, 6097A,98A,99ABCD 6103A,4A,8A,9ABCDEFGHJ,KL;10ABC,16A-18S 6127ABC,40A,42A,46A,53A,58A,60ABCDEF,6G, 6164ABC,68AB,69AB,77ACD,79A,80AB,82A 6184AC,92ABCJ,KL;93AB 6207ABC,9AB,29AB,30AB,32A,33A 536 001,2C 538 000ABC, 1A-3A,5AD,6A 618 072H,75AC,89AB		USX 93-94	583241, 583320	12 Volt	
USX 60-59	75238, 618481	12 Volt	2-US 93		5,5/8,2x13,1x15/18,5	
1-US 60	99562	8 x 15 x 15	1-US 94			
1-US 59	99556	8 x 15 x 15		532024AB,25A,27A 534024A,25A,27A,28A,35A,36A		
	434B,5130A 6020ABCD,23BCDE,33,34AB,35ABCDE 6048,49A,50ABC,73ABCD,77ABC,81ABCDE,6F, 6101AB,21A,22AB,28AB,29A,30A,34ABCDEF,6G, 6136ABD,37ABCDEF,38ABC,39AB,43A,44AB,47AB, 6155ABCEG,57A,61ABCEFH,62ACE,70A,71A, 6172AB,74ABCDEF,75AB,76ABCEG,81A,83ABCFG, 6185ABC,87ABCE,89ACDEF,90AB,95A,97A 6202AB,3ABCD,6AB,8A,12AB,15ABCD,16ABC,17ABCDE, 6219ABC,20ABC,21A,23A,24BCD,26A,27ABCD,31ABCD, 6236BC,37ABCD,38ABCD,40A-42A,44A,45A,47AB, 532000AB,1AB,2ABC,3AB,4ABC,5A,7A,8ABC,9AB, 532010AB,11A,14A,17A,18A,20AB, 533000A-4A 583008 618070,71,73,74,77,78,91, 618358,482,484,490 618565,795					



PS 35
PS 36
PS 58



PS 37
PS 55
PS 64



PS 70
PS 76



PS 81
PS 83
PS 96



PS 82
PS 84
PS 97

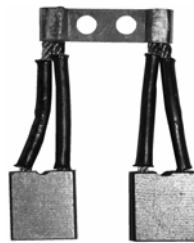

PS 88



PS 106



PS 107

VALEO Paris-Rhone Starter

PSX 35-36	72 621D	12/24 Volt	PSX 88	72 615E (Valeo 182 162)	24 Volt
1-PS 35	33r14	7 x 18 x 14	4-PS 88	53j15	12 x 18 x 20
1-PS 36	33r20	7 x 18 x 14		D15E14-16,19-23,24,T,25-30,T,TE	
	D10L27,29,E31,B32			-----	
PSX 37-58	72 593	12 Volt	PSX 96-97	75 093G (Valeo 182 115)	12 Volt
1-PS 37	33r19	7 x 18 x 14	2-PS 96	70t	10 x 25 x 17
1-PS 58	33r27	7 x 18 x 14	2-PS 97	70t34	10 x 25 x 17
	D8E22,L25,E27,30,31,37,41			D11E131	
	-----			-----	
PSX 55-76	72 616F (Valeo 182 069)	6/12 Volt	PSX 106-107	78 166L (Valeo 182 072)	12 Volt
1-PS 55	44a30	10 x 18 x 14	1-PS 106	27h25	7 x 15 x 14
1-PS 76	44a	10 x 18 x 14	1-PS 107	27h77	7 x 15 x 14
	D8L11,19,20			D8E103	

PSX 64-70 (2)	72 591A (Valeo 182 097)	12 Volt			
1-PS 64	34t19	7 x 18 x 17			
1-PS 70	34t	7 x 18 x 17			
	D10B38-41,44,45				

PSX 64-70 (4)	75 452X (Valeo 182 098,102,103)	12 Volt			
2-PS 64	34t19	7 x 18 x 17			
2-PS 70	34t	7 x 18 x 17			
	D10E47,72-74,79,96				
	D11E79,D109,110,142,143,159,165				

PSX 81-82	72 631G, 300679 (Valeo 182 114)	12 Volt			
2-PS 81	70f	10 x 25 x 17			
2-PS 82	70f34	10 x 25 x 17			
	D11E92,T,104,117,119,T,121,127,129,T,131,137, 141,146,149,153,T,154,155,169,173,176,178				

PSX 83-84	72 630F (Valeo 182 132, 182 145)	24 Volt			
2-PS 83	70j	10 x 25 x 17			
2-PS 84	70j34	10 x 25 x 17			
	D11E81,T,88,89,T,TE,90,T,98,T,TE,99,T, 103,114,122,T,124,125,128,T,130,138T,149 D13E63,T,64-66,T,69,T,70,T,71,73,TE 74,TE,81,T,TE,82T,83-85,88,90TE,95, 100TE,101TE,104TE,105,108TE,111,112,116				

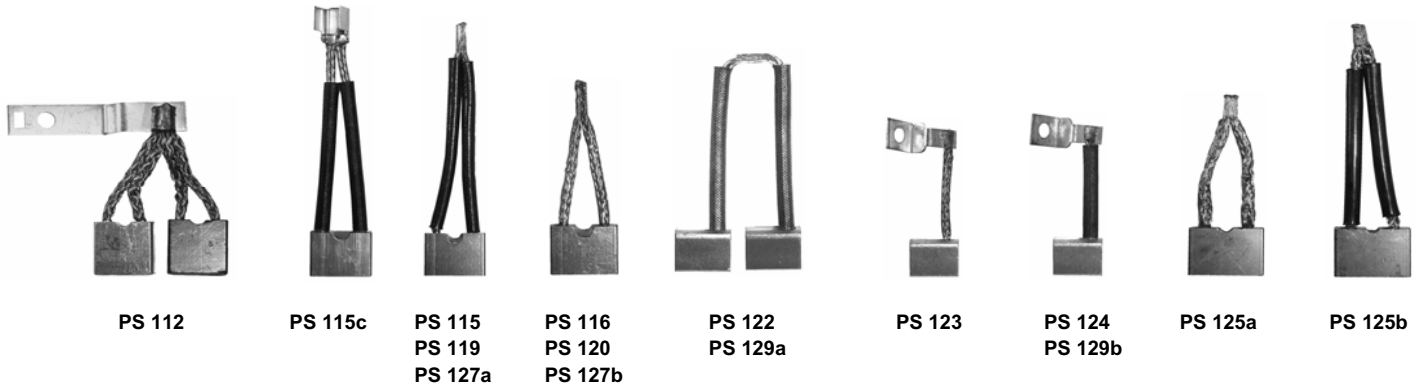

VALEO Paris-Rhone Starter

PSX 112	78 900U (Valeo 182 146)	24 Volt
4-PS 112	47u53 D13E76,77,86TE,87TE,93TE,94TE,96TE,98TE, 107TE,109TE,110TE	10 x 18 x 17

PSX 115-116	92 655V (Valeo 182 064)	12 Volt
1-PS 115	52h	7 x 18 x 14
1-PS 116	52h	7 x 18 x 14
	D8E21,22,L25,E27,30,31,37,41,43,49,50,54,58-60 64,66,70,71,75-78,81-84,86-89,94-98,102, 104,106,108,109,112-115,117-126,129,132-134 136,137,139,140,142,144,147,151,152,158 D9E7,9,11,12,14-22,26-28,34,35,37,41 D10E43,48-50,53,54,57,63-65,69,76,80,84,86	

PSX 115-116K	92 655V (Valeo 182 064)	12 Volt
1-PS 115 c	52h avec cosse	7 x 18 x 14
1-PS 116	52h	7 x 18 x 14
	alternativ zu PSX 115-116	

PSX 115-116-121	92 694G, 92 695H 300.700T (Valeo 182 099,112,113,116,133)	12 Volt
2-PS 115	52h	7 x 18 x 14
2-PS 116	52h	7 x 18 x 14
	D10E59,62,66 D11E58,69,75,78,84,85,108,123,139,T,140,144, 163,164,170,180,181,193	

PSX 119-120	92 656W (Valeo 182 070)	12 Volt
1-PS 119	55h	7 x 15 x 14
1-PS 120	55h	7 x 15 x 14
	D8E26,29,34,L35,E40,44-46,51,52,62, 65,L65,67,73,E74,L80,90-93,E99 107,111,116,130,131,141,148,154	

PSX 122-123-124	92 765Z (Valeo 182 073)	12 Volt
1-PS 122		9,7/4,2x12,4x15
1-PS 123	(cable nu)	9,7/4,2x12,4x15
1-PS 124	(cable isol.)	9,7/4,2x12,4x15
	D8E145,153,155,157	

PSX 125	92 744S (Valeo 182 117)	12 Volt
2-PS 125 a	70t	10 x 25 x 17
2-PS 125 b	70t...	10 x 25 x 17
	D11E118,120,158,160,167T,202	

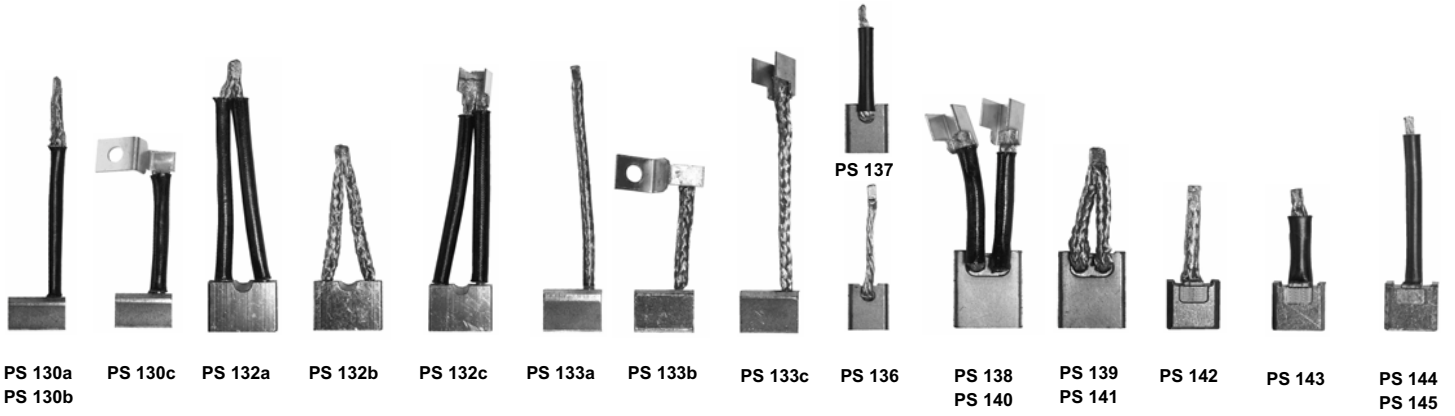

PSX 127	92 824L (Valeo 182 101)	12 Volt
2-PS 127 a	55h	7 x 15 x 14
2-PS 127 b	55h	7 x 15 x 14
	D10E70,72,75,81,83	

PSX 129	92 878G (Valeo 182 065,594 065)	12 Volt
1-PS 129 a	80hb	10,6/6,1x10,3x15
2-PS 129 b	80hb	10,6/6,1x10,3x15
	D9E31,40,43-46,49-55,62,74,75,77,79,85, 87,95,98,100,102,104,111,131,138,140, 200,238,300,771-774,776,851,852	



VALEO Paris-Rhone Starter

PSX 130	92 883, 300.687A (Valeo 182 068)	12 Volt	PSX 138-139 (2)	Valeo 182 054 (jeu de bobines)	12 Volt
1-PS 130 a	(cable 64 mm)	10,6/6,1x10,3x15	1-PS 138	82aa	9 x 18 x 22
1-PS 130 b	(cable 40 mm)	10,6/6,1x10,3x15	1-PS 139	82aa	9 x 18 x 22
2-PS 130 c		10,6/6,1x10,3x15		D9R84 D9R121	
	D9E32				

PSX 131	92 914J (Valeo 182 066) = PSX 133 300 706 (182067)		PSX 140-141 (4)	Valeo 182 051 (jeu de bobines)	12 Volt
	-----		2-PS 140	82ta	9 x 18 x 22
PSX 132	92 925 (Valeo 182 118)	12 Volt	2-PS 141	82ta	9 x 18 x 22
2-PS 132 a	44t	10 x 18 x 14		D9R73,89-91,96,99,105,106,118,122,126, 135,139,142	
2-PS 132 b	44ta	10 x 18 x 14		-----	
	D11E148,156,161,172,177,184, 187,188,191,192,195,272		PSX 142-143		12 Volt
	-----		2-PS 142	185658 cable nu 35 mm	7 x 14 x 13,7
PSX 132 K	92 925 (Valeo 182 118)	12 Volt	2-PS 143	185658 cable isol. 35 mm	7 x 14 x 13,7
2-PS 132a	44 t	10 x 18 x 14		D7R	
2-PS 132 c	44 ta avec cosse	10 x 18 x 14		-----	
	-----		PSX 142-144		12 Volt
PSX 133	300 706Z (Valeo 182 067/594 066)	12 Volt	2-PS 142	187778 cable nu 35 mm	7 x 14 x 13,7
1-PS 133 a	79hb	13,9/6,9x12x15	2-PS 144	187779 cable isol. 55 mm	7 x 14 x 13,7
1-PS 133 b	79hb	13,9/6,9x12x15		D7R5,11,15	
	D9E36,38,39,48,56,57,61,64,66,68-70,76,78, 81-83,86,92-94,101,107-110,113,114, 123-125,127,129,132,136,137,237, 276,278,701,702,861			-----	
	-----		PSX 142-145		12 Volt
PSX 133 E	300 706 (Valeo 182 067)	12 Volt	2-PS 142	185658,187639 cable nu 35 mm, 6 qmm	7 x 14 x 13,7
1-PS 133 a	79hb	13,9/6,9x12x15	2-PS 145	188571,191663 cable isol. 55 mm, 3 qmm	7 x 14 x 13,7
1-PS 133 b	79hb	13,9/6,9x12x15		D7R VW overload protection starter	
2-ressorts					
2-cabochons					
	alternativ zu PSX 133				

PSX 133 K	300706 (Valeo 182 067)	12 Volt			
1-PS 133 b		13,9/6,9x12x15			
1-PS 133 c	avec cosse	13,9/6,9x12x15			
	alternativ zu PSX 133				

PSX 136-137	300 841H, 300 842	12 Volt			
2-PS 136	81ta	7 x 15 x 18,5			
2-PS 137	81ta	7 x 15 x 18,5			
	D10E85,87-90,92,881,882,921,922				



PS 146
PS 148



PS 147
PS 149



PS 152



PS 153



PS 154



PS 155



PS 157



PS 158



PS 159



Ressort



Isolants

VALEO Paris-Rhone Starter

PSX 146-147 594064 jeu de balais et ressort 12 Volt
594072 palier collecteur complet

1-PS 146 184602 4,5/9 x 11 x 14
1-PS 147 4,5/9 x 11 x 14
2-Isolants
1-Ressort

184030,184205
D6RA8,10

SH 1.2 kw

PSX 146-147/0 594064 12 Volt

2 x PS 146/0 sans cosse 4,5/9 x 11 x 14

Alternative Brush-Set with flex only

PSX 148-149 594060 jeu de balais et ressort 12 Volt
594070 palier collecteur complet

1-PS 148 187069,188151,188389 4,5/9 x 11 x 18
1-PS 149 564834 4,5/9 x 11 x 18
2-Isolants
1-Ressort

182505,551
183199,212
184413,470,471
185310,874



D6RA5,6,12,16,18,20,38,45,61

SH 1.1/1.2 kw

PSX 148-149/0 594060 12 Volt

2 x PS 148/0 sans cosse 4,5/9 x 11 x 18

Alternative Brush-Set with flex only



PSX 148-154 12 Volt

1-PS 148 187069,188151,188389 4,5/9 x 11 x 18
1-PS 154 188388 4,5/9 x 11 x 18
2-Isolants
1-Ressort



D6RA



PSX 148-157 594063,123-125,127,160,161,165,174, 179,254 12 Volt
jeu de balais et ressort
594129,130,253 palier collecteur complet

1-PS 148 187069,188151,188389 4,5/9 x 11 x 18
1-PS 157 186772,187068,188855 4,5/9 x 11 x 18
2-Isolants
1-Ressort

183450,940
184231,348,456,457,550,646,727,880,881,
185243-246,597,690,722,740-742,758,850
186045,140,214,215,269,276,424,441,442,
476,625,626,708,887



187027,259,332,515
188339

D6RA7,13,15,17,19,21-23,25-30,32,34,39-44,46,48-50
52-56,59,60,63,66,70,72,75,141,161,661,721

SH 1.0/1.05/1.1/1.2/1.3 kw
SIH 1.1/1.2 kw

PSX 148-158 594169,386 jeu de balais et ressort 12 Volt
594132,385 palier collecteur complet

1-PS 148 187069,188151,188389 4,5/9 x 11 x 18
1-PS 158 186865,187870,188430 4,5/9 x 11 x 18
1-Ressort

182549
185547,722
186060,502,848,886
187026
188401,564
190549



SH 1.0/1.1/1.2/1.4 kw

D6RA33,37,47,51,57,101,133,571

PSX 148-159 594317,360 jeu de balais et ressort 12 Volt
594318,323, 359,364 palier collecteur complet

1-PS 148 187069,188151,188389 4,5/9 x 11 x 18
1-PS 159 186925,187737,188150,188803 4,5/9 x 11 x 18
2-Isolants
1-Ressort

1875047,507,509
188102,103,652-654
190652



SH 1.0/1.1

D6RA67,78-81,91,167,180,181

PSX 152-153 182037 24 Volt

4-PS 152 10 x 18 x 17
2-PS 153 10 x 18 x 17

D13E117TE-123TE
D13HP701-705,709

PSX 155 (3) 594290 Porte-Balais complet 12 Volt

3-PS 155 187144 6,4 x 8 x 11

187212,188728
190677-79,779



D7E 1,16,29-32
SH 0.7/0.8/0.85 kw



PS 155



PS 156



PS 160



PS 161



PS 163



PS 164











PS 166
PS 168
PS 169



PS 167
PS 170

VALEO Paris-Rhone Starter

PSX 155 (4)	594351 Porte-Balais complet	12 Volt
4-PS 155	187144	6,4 x 8 x 11
	187682 188063,329,707 190080,166,167,227,229 D7E4,6,8,15,18-20,22,27 D7ED28 SH 0.8/0.85/1.0 kw Mercedes A	
PSX 156	594381 Porte-Balais complet	12 Volt
4-PS 156	187888	6,4 x 8 x 11
	188279,190172,190396 D7ES 2,4,5 SIH 0.9 kw VW	
PSX 160	190097 Porte-Balais = PSX 160-164	190986
PSX 160-163	= PSX 163-164	190987
PSX 160-164	190986, 191060, Porte-Balais 191821-823	12 Volt
2-PS 160 2-PS 164	balais negative avec 2 shunts 28mm balais positive avec 1 shunt 25,5mm	7 x 13 x 11,5 7 x 13 x 11,5
	190365 D7G 3,4,6 SH 1.5-1.7 kw overload protection starter Audi,BMW, PSA,	
PSX 161		12 Volt
4-PS 161	1903131	7 x 14 x 13,7
	D8R 1,27 SH 1.9/2.4 kw	
PSX 163-164	190987,191824 Porte-Balais	12 Volt
2-PS 163 2-PS 164	balais negative avec 2 shunts 50mm balais positive avec 1 shunt 25,5mm	7 x 13 x 11,5 7 x 13 x 11,5
	D7G SIH overload protection starter VW	
PSX 166-167		12 Volt
2-PS 166 2-PS 167	191849 191771	3,9/6,4 x 10 x 15,5 3,9/6,4 x 10 x 15,5
	D6G1,2,3,5 SH c/w BMW, Fiat, Mercedes, PSA	

PSX 168-167		12 Volt
2-PS 168 2-PS 167	192285 191771	3,9/6,4 x 10 x 15,5 3,9/6,4 x 10 x 15,5
	D6GSP19 SH c/w overload protection starter Audi	
PSX 169-170		12 Volt
2-PS 169 2-PS 170	191772 191773	3,9/6,4 x 10 x 15,5 3,9/6,4 x 10 x 15,5
	D6GS11-13 SIH a/c overload protection starter VW	

Repair-Kits und komplette Systeme für D6RA, D7E, D7G und D7R Starter finden Sie in unserem Katalog
ERSATZTEILE FÜR STARTER UND LICHTMASCHINEN

Repair-Kits and Systems for D6RA, D7E, D7G und D7R Starters see our catalogue
SPARE PARTS FOR STARTERS AND ALTERNATORS

Kits de réparation et nécessaires de rechange pour démarreurs D6RA, D7E, D7G et D7R consultez notre catalogue
PIECES DE RECHANGE POUR DEMARREURS ET ALTERNATEURS



Achtung! Zweistoffkohlen

Attention! 2-component brushes

Attention! charbons á 2 composants

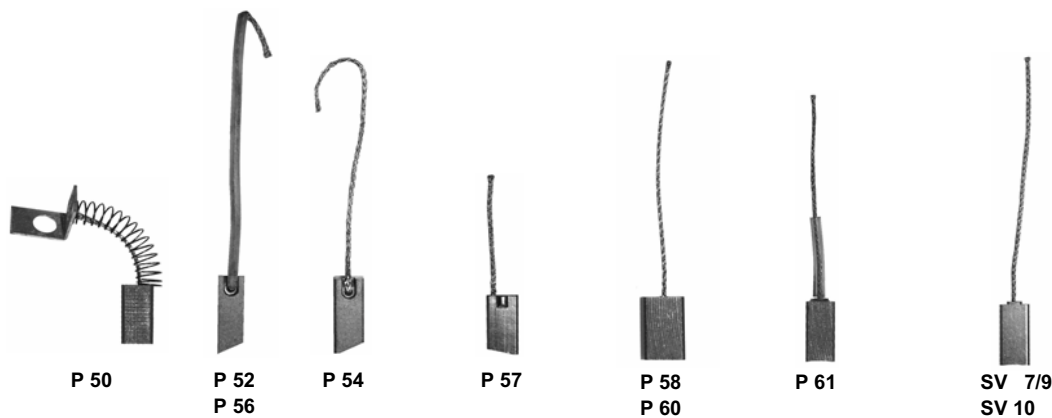

VALEO	Motorola	Paris-Rhone	SEV	Alternator		
PX 50	073742, 182231 Porte-Balais: 056473	6-24 Volt		PX 61	Regulateur 593260, 593357	24 Volt
2-P 50	IP9	7 x 5 x 14		2-P 61	2546443	6,4 x 4,6 x 14,2
	A13R3L,7,8,10L,T,11L,LT,12LT,13L,LT,14LT,15, 17L,LT,18T,20-22,24,26,28,29,30L,32L, 34L-45L,46LT,47LT,48,49LT,50LT,51L,52,53 54L-58L,59,60,61L,LT,62L,64L,65-70,71L, 72,75-77,79,91L,LT, 108-110,111L,LT,122,130,168,181 A16R17,20,20T,21T,22,23T,25,26,36T-39T,44T-46T, 49T,53T,57T,59T,60T				A14Vi19,20	
	-----				2541873 2541916 -----	
PX 52-54	075411	12 Volt		SVX 7/9	300 821	12/24 Volt
	Porte-Balais: 095788,095984,096026,096334				Porte-Balais: Motorola 494487-494489 503001,006-009,019,025	
1-P 52	(8d) 8m84	7 x 5 x 19			Paris Rhone 092859,092967,300796	
1-P 54	8m	7 x 5 x 19		2-SV 7/9	SEV 71931093	6,4 x 4,6 x 14,5
	A11M3-7,9-14; A11R1-3 A12M1-3,5-10,18 A12R1-6,8-14,19-21,23,26-28,47-49 A13M2-9,11-17 A13R63,73T,74,78T,80T-90T,92,95-99, 104,105,115-117,119-121,123-129,131-134, 135T,136-138,139T,140,141,143-145,149-154, 156,157,159,160,162T,163T,166,167,169-172T, 174-180,183-191T,194-196,198,199,202,205, 210,212,213,215,219,223-225,235,261,265				Valeo 300796	

PX 56	092669,092746,092850,096302, 300 686 Porte-Balais: 092672,092743	12/24 Volt			Motorola 2518032-452 2940020-930 2941095-447 9AL2502K-6027K 9AR2500K-6095G	
2-P 56	8d 84	7 x 5 x 19			SEV 7120,7121,7122,7123,7124... , 7127,7129,7131,7133,7134... , 7142,7147,7149,7152,7159... , 7163,7164,7165,7177,7192... , 7194,7197,7199... ,	
	A11R4 A12R16,17,42 A13R113T,173,182TE,201TE A16R100-103,105,106,120-124,140,141,150-152, 160,161,180,190-194,200,210-212,220-222, 230-233,240,242,246,250,260-262				Valeo/PR A11Vi A12M9,11,15-17 A12R22,24,25,33,34,36,38,43-46,50,52,53 A13E.. A13N1M,2M,6,7,10,12-15,17-20,25-27,28M, 29-32,33M,34,35M36M,38-43,46,47,49,50, 52,53,55M-59M,60T,64,65,66M,80-95,97, 104,106-114,116-121,123-130,133,136- 139,143M,144,146T,147M-149M,150,151, 152M,156-165,166M,167,169,171-173, 175-183,185,186M,187,188,236M,283M	
	-----				A13R aus AK 2000 A13V2,5,7 A13Vi...	
PX 57	Porte-Balais 098627, 098689 300875	12/24 Volt			A14N1,2,4,9-14,16,18,22,23,29M,30M,31T,35, 36,38,40,42,50,53-56,59,60,62-65,67,69- 71,73,75-78,80,81M,82-86,88-93,95-97, 99,100M,101-103,106,107,110M,113,115M, 116M,117,118M,119M,121,122M,123-125, 128,130-132,134,137,140,141M,142,151, 196M,206M	
2-P 57	9m	7 x 5 x 14,5			A14V.. A14Vi10,11,13-18,22-25,27-31,35	
	A12R30-32,37 A13R192,214,244,245 A14R3,6,7,8T-10T,11,12T-15T,17,18T 21T,22,26-29,35,,38T,41,47				-----	

PX 58	Porte-Balais 300665, 300682	12/24 Volt		SVX 10		12 Volt
2-P 58		10 x 5 x 17		2-SV 10	2521679E	6,4 x 4,6 x 14,5
	A13N4T,5T,11,21T,22T,61T,140T,174,190,255,257 A14N3T,28T,32T,39,104,114T,133,135,138 A14R33,39T				flex section 0,5 mm ² flex length 80 mm	
	-----				A13V/Vi A14V/Vi	
PX 60	Porte-Balais 300722					
2-P 60		6,35 x 4,6 x 15,4				
	A12R35T,57,58,351T A13N51,69,76 A14N19,37 A14R34T,54T,341T,541T-543T					



GS 1, GS 7
GS 8, GS 11



GS 4



GS 9



GS 15



GS 16



GS 17



HPI 1

STAPLERKOHLEN BRUSHES FOR FORK LIFTS

KOHLEN FÜR HILFSMOTORE AUXILIARY BRUSHES

BOSCH

GSX 1	2 137 014 006	24 Volt
4-GS 1	2 134 320 036	6 x 22 x 25,5
	KND(R) 24V 500W	
	0 136 401 006-008 402 007 403 002-007	

GSX 4	2 137 014 014	12/24 Volt
4-GS 4	2 134 320 015	9 x 13 x 25,5
	INA(R) 12V 1500W 24V 2000W	
	0 136 355 011,013,029,030,038,045	

GSX 7	2 137 014 025	24/48 Volt
4-GS 7	2 134 320 056	6 x 28 x 30,5
	MM/RQL 24V 1800W QR 24V 1000/2500W QRD 24V 1200W QRL 24V/48V 1000/1800/1900/3000W	
	0 136 500 009,025,026,028 501 001,003,004,010,011,013,016,020, 021,032,033,040,045,046,051 504 011	

GSX 8	2 137 014 026	24/48 Volt
4-GS 8	2 134 320 059	8 x 28 x 30,5
	QR 24V 1500W QRL 24V/48V 1500/3000/3700W	
	0 136 500 029,031-033,035,036,039-042 501 042,043,049,055,056,060-062,065, 069,071-073,075-077,079-081,083- 088,090,091,093,095-097 503 014,015	

GSX 9	2 137 014 027	12/24 Volt
4-GS 9	2 134 320 024	9 x 26 x 25,5
	INA 12 / 24V	
	0 136 355 014,016,018,021,023-025, 031,032,037,040	

GSX 11	2 137 014 030	48 Volt
4-GS 11	2 134 320 007, 009	10 x 28 x 30,5
	TRL 48V 3000W	
	0 136 602 009 603 001	

GSX 15	2 137 014 038	12/24 Volt
4-GS 15	2 134 320 066	9 x 26 x 25,5
	INA 12V 1400W 24V 2300W	
	0 136 350 010 352 005 353 010,011 355 049,050,57-61,064-068,070-072, 074,076-078,081	
	Hesselman	

GSX 16-17	2 137 014 040	24/48 Volt
3-GS 16	2 134 320 038	10 x 50 x 30
1-GS 17	mit Meldelitze	10 x 50 x 30
	0 136 500 034 501 054,066,067 503 010	

HPIX 1	HPI	12 Volt
4-HPI 1	balais pour moteur direction assistee	7 x 12,5 x 21,2
	Renault Clio, Kangoo, Twingo	

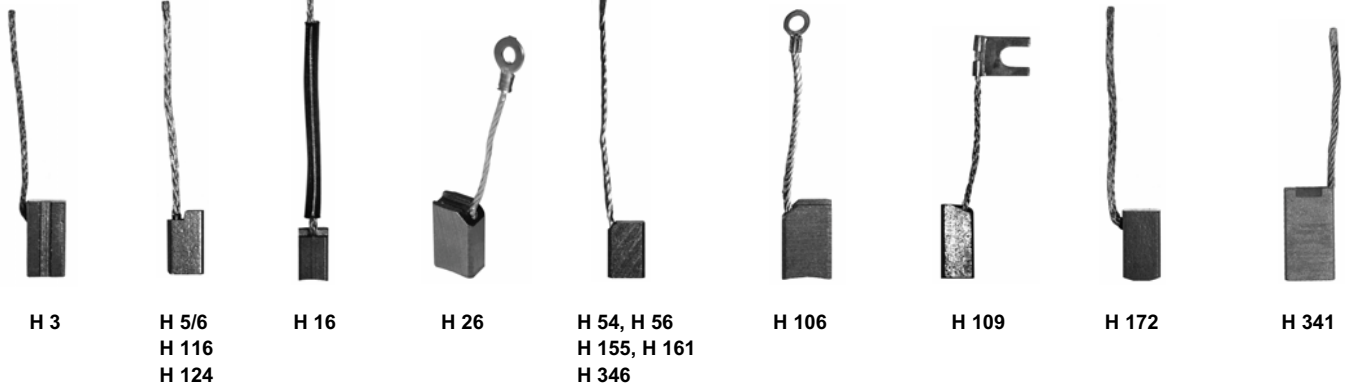

HEIZUNGSKOHLLEN BRUSHES FOR HEATER MOTORS

AVOG					
HX 106			HX 346	3 137 014 111	
2-H 106	00-14-16-31 -----	12 x 8 x 21	2-H 346	3 134 320 164 / 346	8 x 6,3 x 14
				DPG12, DRB, DRH12 0 130 103 ... 104 001 105 ... 107 001,003 -----	
	BOI-WO			DUCELLIER	
HX 54			HX 16		
2-H 54	EP523BOS	5 x 6,4 x 10	2-H 16	92 330 / 90 177 -----	6 x 6 x 11,5
	Heat-on -----			ELEKTROLUX	
	BOSCH		HX 56		
HX 116	3 137 014 109 / 100		2-H 56	Volvo KS3442/21/140 -----	5 x 6 x 12,7
2-H 116	3 134 320 026 / 025	6,3 x 6,3 x 11		LEECE-NEVILLE	
	CPH, CRG, GRH 0 130 056 ... 057 ... 059 ... 065 001,008 997 005 -----		HX 3		
HX 124	3 137 014 123 / 163		2-H 3	(H 3 R) -----	7,1 x 7,1 x 14,3
2-H 124	3 134 320 035 / 061	8 x 8 x 14		LUCAS / SMITH	
	DPC, EPA12 0 130 106 001,003,005,008,012,014,016 205 001 -----		HX 6		
HX 155	3 137 014 171		2-H 5/6	Lucas EWD Smith eHS 340, MKI -----	6,3 x 6,3 x 11,9
2-H 155	3 134 320 155	8 x 6,3 x 11		WEBASTO	
	CPA, CPB, CPL 0 130 061 ... 063 ... 068 001,004,006,009,011,013,017 -----		HX 26		
HX 161	3 137 014 162		2-H 26	-----	9 x 6 x 16,5
2-H 161	3 134 320 161	6,3 x 5 x 12,5	HX 109		
	CPK 0 130 106 002,004,007,010,015,017,019, 020,024,025,028-035 -----		2-H 109	30HL1A, 1599-1721-0602	5 x 6,4 x 15
HX 172	3 137 014 202				
2-H 172	3 134 320 101 / 172	8 x 8 x 15			
	JPK24 0 130 701 019 -----				
HX 341					
2-H 341	3 134 320 341 -----	8 x 10 x 19,5			

Assembly Instructions for Bosch Gear-Starter Brushes

Starter-Unit EV 2,2 KW 12 Volt 0 001 218 ...

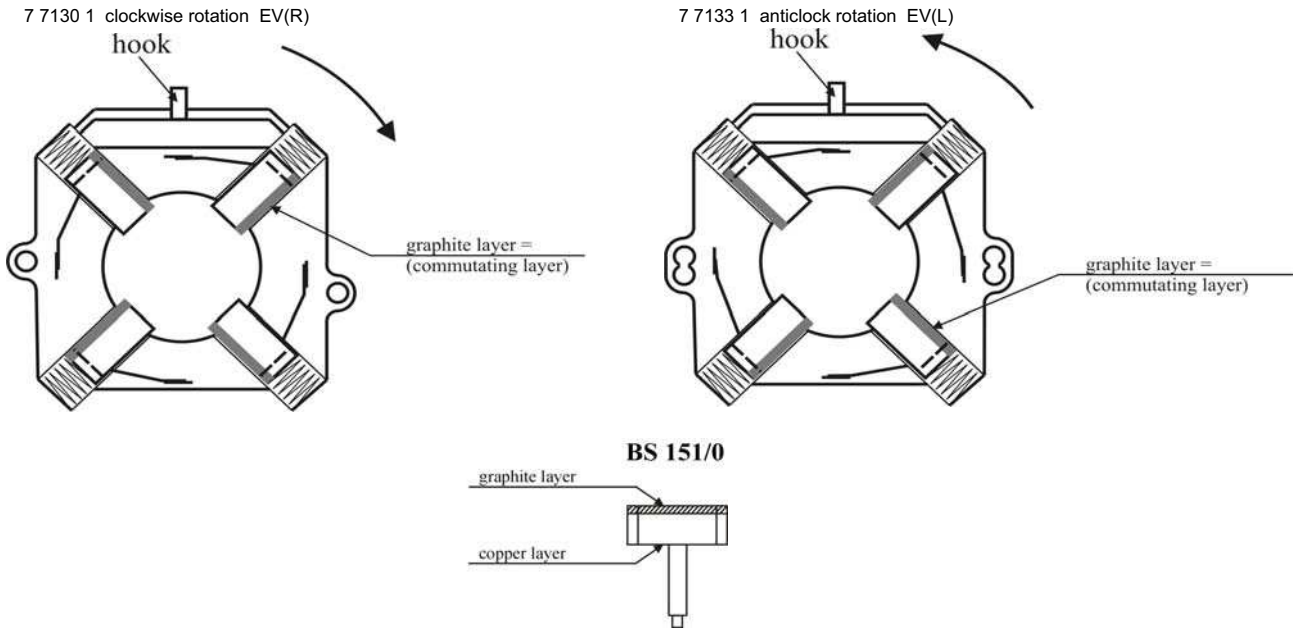

Starter-Unit DW 1,1 KW 12 Volt 0 001 108 ...

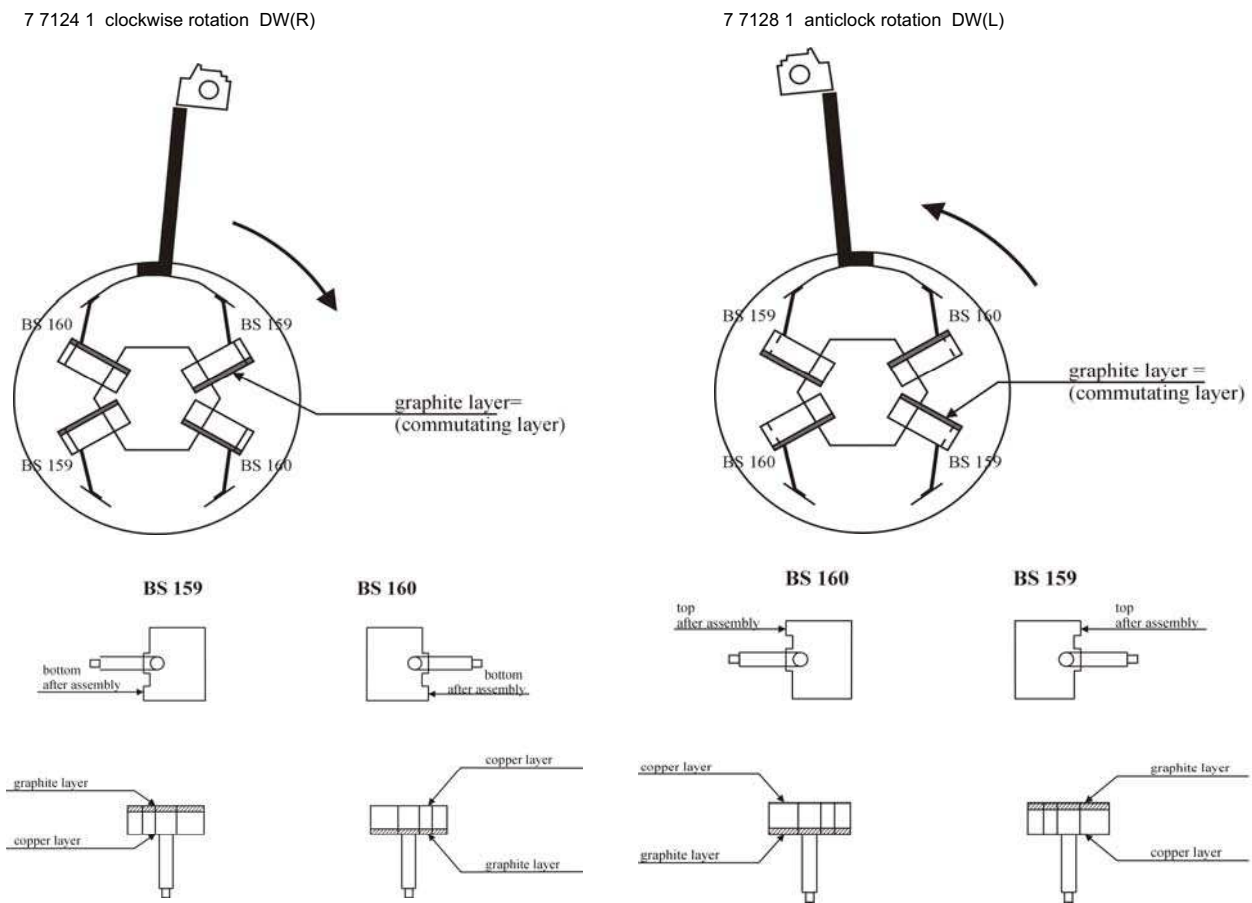

VERGLEICHSLISTE DER ARTIKELNUMMERN

CROSS REFERENCES

LISTE DE CORRESPONDANCE ENTRE LES REFERENCES

CONFRONTARE L'ELENCO DEI ARTICOLI NUMERO

ORIGINAL-REF.	EURO-REF.	ORIGINAL-REF.	EURO-REF.	ORIGINAL-REF.	EURO-REF.
BOSCH					
1 004 320 051	BS 49	1 004 320 910	BS 140	1 107 014 116	BX 104 (2)
1 004 320 055	BS 43	1 004 320 911	BS 146	1 107 014 117	BX 104 (2)
1 004 320 059	BS 43	1 004 320 912	BS 151	1 107 014 118	BX 68 (4)
1 004 320 063	BS 53 / 59	1 007 014 038	BSX 104 (2)	1 107 014 119	BX 68 (4)
1 004 320 067	BS 49	1 007 014 100	BSX 12	1 107 014 120	BX 181
1 004 320 069	BS 76 /104 / 105	1 007 014 101	BSX 93	1 107 014 122	BX 192 (4)
1 004 320 071	BS 76 /104 / 105	1 007 014 102	BSX 52	1 107 014 124	BX 181
1 004 320 072	BS 53 / 59	1 007 014 103	BSX 52	1 107 014 125	BX 145
1 004 320 076	BS 75	1 007 014 105	BSX 36	1 107 014 126	BSX 49
1 004 320 082	BS 76 /104 / 105	1 007 014 106	BSX 33	1 107 014 127	BX 181
1 004 320 100	BS 152 = BS 140/0	1 007 014 107	BSX 34	1 107 014 128	BX 135
1 004 320 101	BS 149 / 154 / 156	1 007 014 109	BSX 35	1 107 014 129	BX 181
1 004 320 102	BS 149 / 154 / 156	1 007 014 112	BSX 53 / 59 (2)	1 107 014 130	BX 135
1 004 320 103	BS 149 / 154 / 156	1 007 014 113	BSX 104 (2)	1 107 014 132	BX 135
1 004 320 105	BS 152 = BS 140/0	1 007 014 114	BSX 104 (2)	1 107 014 134	BX 131
1 004 320 106	BS 152 = BS 140/0	1 007 014 117	BSX 53 / 59 (2)	1 107 014 135	BX 145
1 004 320 110	BS 157	1 007 014 118	BSX 105 (2) S	1 107 014 136	BX 131
1 004 320 111	BS 158	1 007 014 119	BSX 69	1 107 014 137	BX 131
1 004 320 112	BS 151/0	1 007 014 121	BSX 76	1 107 014 138	BX 169
1 004 320 113	BS 159	1 007 014 123	BSX 43 (4)	1 107 014 139	BX 165
1 004 320 114	BS 160	1 007 014 126	BSX 98	1 107 014 140	BX 165
1 004 320 118	BS 175	1 007 014 127	BSX 106	1 107 014 142	BX 169
1 004 320 119	BS 176	1 007 014 128	BSX 121	1 107 014 144	BX 169
1 004 320 136	BS 166	1 007 014 129	BSX 124	1 107 014 145	BX 181
1 004 320 140	BS 159	1 007 014 130	BSX 125	1 107 014 146	BX 181
1 004 320 141	BS 160	1 007 014 131	BSX 98	1 117 014 100	NOX 15
1 004 320 142	BS 158	1 007 014 133	BSX 128	1 124 320 000	B 151
1 004 320 143	BS 157	1 007 014 134	BSX 132	1 124 320 002	B 170 / 198
1 004 320 146	BS 159	1 007 014 135	BSX 133	1 124 320 013	B 182
1 004 320 147	BS 160	1 007 014 137	BSX 146	1 124 320 024	B 185
1 004 320 148	BS 157	1 007 014 138	BSX 140	1 124 320 027	B 185
1 004 320 149	BS 158	1 007 014 139	BSX 149	1 124 320 028	B 182
1 004 320 152	BS 158 K Mercedes	1 007 014 140	BSX 159-160 (4)	1 124 320 029	B 182
1 004 320 153	BS 157 K Mercedes	1 007 014 141	BSX 156	1 124 320 034	B 185
1 004 320 154	BS 175	1 007 014 143	BSX 151	1 124 320 035	B 185
1 004 320 155	BS 176	1 007 014 144	BSX 152	1 124 320 039	B 199
1 004 320 156	BS 175	1 007 014 145	BSX 154	1 124 320 040	B 185
1 004 320 157	BS 176	1 027 014 106	NOX 29	1 124 320 045	B 201
1 004 320 158	BS 196	1 104 320 002	B 135 / 165 / 181	1 124 320 046	B 202
1 004 320 161	BS 182	1 104 320 008	B 135 / 165 / 181	1 124 320 051	B 204
1 004 320 162	BS 183	1 104 320 014	B 135 / 165 / 181	1 124 320 061	B 209
1 004 320 163	BS 184	1 104 320 017	B 135 / 165 / 181	1 124 320 063	B 204
1 004 320 164	BS 185	1 104 320 025	B 169 / 131 / 145	1 124 320 070	B 204
1 004 320 165	BS 158	1 104 320 031	B 169 / 131 / 145	1 124 320 073	B 214
1 004 320 166	BS 157	1 104 320 037	B 169 / 131 / 145	1 124 320 074	B 204
1 004 320 167	BS 159	1 104 320 039	B 169 / 131 / 145	1 124 320 075	B 215 / 218
1 004 320 168	BS 160	1 104 320 044	B 135 / 165 / 181	1 124 320 079	B 204
1 004 320 169	BS 175	1 104 320 047	B 135 / 165 / 181	1 127 014 000	BX 151
1 004 320 170	BS 176	1 104 320 065	BS 76 /104 / 105	1 127 014 001	BX 182
1 004 320 171	BS 157 K Mercedes	1 107 014 016	BX 181	1 127 014 002	BX 198
1 004 320 172	BS 158 K Mercedes	1 107 014 018	BX 68 (4)	1 127 014 004	BX 185
1 004 320 175	BS 200	1 107 014 100	BX 169	1 127 014 005	BX 185
1 004 320 176	BS 201	1 107 014 101	BX 145	1 127 014 006	BX 185
1 004 320 177	BS 204	1 107 014 102	BX 145	1 127 014 007	BX 185
1 004 320 178	BS 205	1 107 014 104	BX 131	1 127 014 008	BX 185
1 004 320 900	BS 98 / 126/128	1 107 014 105	BX 145	1 127 014 009	BX 182
1 004 320 901	BS 106 / 124 / 132	1 107 014 107	BX 131	1 127 014 010	BX 199
1 004 320 902	BS 121	1 107 014 108	BX 131	1 127 014 011	BX 185
1 004 320 903	BS 106 / 124 / 132	1 107 014 109	BX 131	1 127 014 012	BX 190
1 004 320 904	BS 97 / 125	1 107 014 110	BSX 43 (4)	1 127 014 013	BX 185
1 004 320 905	BS 98 / 126/128	1 107 014 112	BX 192 (4)	1 127 014 014	BX 198
1 004 320 906	BS 213	1 107 014 113	BX 192 (4)	1 127 014 015	BX 199
1 004 320 907	BS 98 / 126/128	1 107 014 114	BX 104 (2)	1 127 014 016	BX 201
1 004 320 909	BS 133	1 107 014 115	BX 104 (2)	1 127 014 017	BX 202

ORIGINAL-REF.	EURO-REF.	ORIGINAL-REF.	EURO-REF.	ORIGINAL-REF.	EURO-REF.
BOSCH					
1 127 014 018	BX 204	1 917 000 526	PSX 83-84	1 987 000 026	JA-SX 56-3
1 127 014 019	BX 209	1 917 000 529	PSX 88	1 987 120 000	JA-AX 9
1 127 014 020	BX 202	1 917 000 535	PSX 64-70 (2)	1 987 120 001	JA-AX 20 / 29
1 127 014 021	BX 209	1 917 000 5351	PSX 115-116 K	1 987 120 002	JA-SX 63
1 127 014 022	BX 204	1 917 000 536	PSX 96-97	1 987 120 003	JA-AX 25 / 18
1 127 014 023	BX 204	1 917 000 539	PSX 55-76	1 987 120 004	JA-AX 24
1 127 014 024	BX 214	1 917 000 542	PSX 132	1 987 120 010	JA-AX 25 / 18
1 127 014 025	BX 204	1 917 000 543	PSX 119-120	1 987 120 022	JA-AX 19
1 127 014 026	BX 215	1 917 000 544	PSX 64-70 (2)	1917 000 161	RX 120 (4)
1 127 014 027	BX 215	1 917 000 552	PSX 106-107	1917 000 162	RX 120 (2)
1 127 014 028	BX 213	1 917 000 553	PSX 112	1917 000 201	USX 44-21
1 127 014 030	BX 204	1 917 000 554	PSX 83-84	1917 012 105	RX 103 F
1 127 014 031	BX 219	1 917 000 556	PSX 115-116-121	1917 012 400	SVX 7 / 9
1 917 000 051	ASX 11	1 917 000 558	PSX 115-116-121	1917 012 401	SVX 7 / 9
1 917 000 052	ASX 11	1 917 000 559	PSX 119-120	2 000 014 078	BSX 100
1 917 000 055	ASX 7	1 917 000 560	PSX 122-123-124	2 004 320 006	BS 12
1 917 000 056	ASX 7	1 917 000 563	PSX 129	2 004 320 008	BS 39 / 40
1 917 000 057	ASX 11	1 917 000 564	PSX 132	2 004 320 009	BS 12
1 917 000 059	ASX 19 (4)	1 917 000 565	JSX 21-22	2 004 320 013	BS 34 / 72
1 917 000 153	RX 60	1 917 000 575	PSX 130	2 004 320 016	BS 153
1 917 000 154	RX 70 (4)	1 917 000 576	PSX 133 / PSX 131	2 004 320 017	BS 147
1 917 000 155	RX 87	1 917 000 577	JSX 21-22	2 004 320 026	BS 70
1 917 000 156	RX 95	1 917 000 578	MASX 17-18	2 004 320 030	BS 75
1 917 000 158	RX 92	1 917 000 579	USX 93-94	2 004 320 033	BS 97 / 125
1 917 000 203	USX 50-51 (2)	1 917 010 159	UX 58 (65)	2 004 320 035	BS 116
1 917 000 204	USX 50-51 (4)	1 917 010 205	JX 16	2 004 320 038	BS 139
1 917 000 205	USX 60-59	1 917 010 207	JX 18	2 004 320 043	BS 52 / 74
1 917 000 206	USX 60-59	1 917 010 208	JX 22	2 004 320 044	BS 52 / 74
1 917 000 207	USX 60-59	1 917 010 209	JX 26	2 004 320 053	BS 36 / MAS 4
1 917 000 208	USX 60-59	1 917 010 300	LAX 9	2 004 320 057	BS 148
1 917 000 210	USX 60-59	1 917 010 301	LAX 31	2 004 320 058	BS 148
1 917 000 211	USX 73-85	1 917 010 302	LAX 31-32	2 004 320 061	BS 148
1 917 000 213	USX 76-77-78	1 917 010 305	LAX 23	2 004 320 062	BS 148
1 917 000 215	USX 91-92	1 917 010 391	PLX 5	2 004 320 066	BS 33
1 917 000 250	JSX 5	1 917 010 415	PX 53	2 004 320 068	BS 34 / 72
1 917 000 251	JSX 9	1 917 010 447	FEX 27	2 004 320 074	BS 44
1 917 000 252	JSX 12	1 917 010 448	FEX 28	2 004 320 080	BS 44
1 917 000 253	JSX 13 (4)	1 917 012 001	EX 87 R (CHX 1)	2 004 320 084	BS 35
1 917 000 254	JSX 15	1 917 012 052	AX 32	2 004 320 085	BS 44
1 917 000 255	JSX 16	1 917 012 104	RX 103	2 004 320 087	BS 34 / 72
1 917 000 257	JSX 17	1 917 012 152	UX 67-68	2 004 320 089	BS 35
1 917 000 259	JSX 18	1 917 012 154	UX 71-72	2 004 320 091	BS 35
1 917 000 260	JSX 19	1 917 012 155	UX 79-80	2 004 320 092	BS 35
1 917 000 261	JSX 14	1 917 012 157	UX 84	2 004 320 098	BS 35
1 917 000 300	FX 5-6	1 917 012 158	UX 82-83/0	2 004 320 099	BS 187
1 917 000 354	LASX 15-16	1 917 012 159	UX 85	2 004 320 101	BS 134
1 917 000 355	LASX 15-27	1 917 012 160	UX 87-88	2 004 320 102	BS 144
1 917 000 357	LASX 36	1 917 012 200	JX 24-25	2 004 320 103	BS 135
1 917 000 358	LASX 37-38-39	1 917 012 202	JX 28-29	2 004 320 104	BS 145
1 917 000 359	LASX 40-41	1 917 012 203	JX 30-31	2 004 320 108	BS 163 / 167
1 917 000 360	LASX 42	1 917 012 204	JX 32	2 004 320 109	BS 164 / 168
1 917 000 361	LASX 30-31-32	1 917 012 303	LAX 33	2 004 320 114	BS 39 / 40
1 917 000 363	LASX 43-44/0 w/o.term.	1 917 012 351	PX 50	2 004 320 122	BS 93
1 917 000 400	MASX 3	1 917 012 352	PX 52-54	2 004 320 124	BS 102
1 917 000 401	MASX 4	1 917 012 353	PX 52-54	2 004 320 125	BS 93
1 917 000 500	PSX 37-58	1 917 012 354	PX 52-54	2 004 320 130	BS 12
1 917 000 503	PSX 115-116	1 917 012 403	JX 36-37	2 004 320 135	BS 155 = BS 134/0
1 917 000 504	PSX 115-116-121	1 917 012 404	JX 38-37	2 004 320 139	BS 139
1 917 000 505	PSX 35-36	1 917 012 405	JX 39-37	2 004 320 140	BS 62
1 917 000 506	PSX 37-58	1 917 012 407	UX 87-89	2 004 320 141	BS 67
1 917 000 507	PSX 37-58	1 917 012 408	UX 92	2 004 320 144	BS 85
1 917 000 509	PSX 115-116	1 917 012 409	UX 93	2 004 320 154	BS 53 / 59
1 917 000 512	PSX 119-120	1 917 012 410	UX 94	2 004 320 158	BS 196
1 917 000 513	PSX 119-120	1 917 012 413	FEX 26	2 004 320 163	BS 198
1 917 000 517	PSX 55-76	1 917 700 476	PLSX 3	2 004 320 164	BS 199
1 917 000 519	PSX 64-70 (4)	1 987 000 004	JA-AX 32	2 004 320 165	BS 170
1 917 000 521	PSX 115-116	1 987 000 005	JA-SX 66-67	2 004 320 166	BS 171
1 917 000 522	PSX 115-116-121	1 987 000 006	JA-SX 57-58	2 004 320 172	BS 75
1 917 000 523	PSX 115-116-121	1 987 000 007	JA-SX 29	2 004 320 173	BS 75
1 917 000 524	PSX 115-116-121	1 987 000 009	JA-SX 15-6 (4)	2 004 320 176	BS 186
1 917 000 525	PSX 81-82	1 987 000 010	JA-SX 69-70 (4)	2 004 320 177	BS 187

ORIGINAL-REF.	EURO-REF.	ORIGINAL-REF.	EURO-REF.	ORIGINAL-REF.	EURO-REF.
BOSCH					
2 004 320 178	BS 186	2 007 014 050	BSX 96	2 134 320 056	GS 7
2 004 320 180	BS 75	2 007 014 051	BSX 100	2 134 320 059	GS 8
2 004 320 196	BS 170	2 007 014 052	BSX 96	2 134 320 066	GS 15
2 004 320 197	BS 171	2 007 014 053	BSX 102	2 137 014 003	BSX 12
2 004 320 203	BS 62	2 007 014 054	BSX 104 (2)	2 137 014 005	BX 188
2 004 320 207	BS 67	2 007 014 055	BSX 104 (2)	2 137 014 006	GSX 1
2 004 320 208	BS 85	2 007 014 056	BSX 96	2 137 014 014	GSX 4
2 004 320 217	BS 100 / 113	2 007 014 057	BSX 97	2 137 014 025	GSX 7
2 004 320 218	BS 100 / 113	2 007 014 058	BSX 116	2 137 014 026	GSX 8
2 004 320 220	BS 96 / 118 / 136	2 007 014 059	BSX 129/130	2 137 014 029	GSX 11
2 004 320 223	BS 96 / 118 / 136	2 007 014 060	BSX 129/130	2 137 014 030	GSX 11
2 004 320 230	BS 139	2 007 014 061	BSX 148	2 137 014 038	GSX 15
2 004 320 240	BS 178	2 007 014 062	BSX 134-144	3 107 014 101	NOX 16
2 004 320 241	BS 179	2 007 014 063	BSX 135-145	3 134 320 025	H 116
2 004 320 242	BS 180	2 007 014 064	BSX 96	3 134 320 026	H 116
2 004 320 243	BS 181	2 007 014 065	BSX 137-143	3 134 320 035	H 124
2 004 320 244	BS 172	2 007 014 066	BSX 153	3 134 320 061	H 124
2 004 320 245	BS 173	2 007 014 067	BSX 147	3 134 320 101	H 172
2 004 320 249	BS 174	2 007 014 068	BSX 137-143	3 134 320 155	H 155
2 004 320 251	BS 148	2 007 014 069	BSX 138-142	3 134 320 161	H 161
2 004 320 253	BS 148	2 007 014 070	BSX 148	3 134 320 164	H 346
2 004 320 254	BS 148	2 007 014 071	BSX 155	3 134 320 172	H 172
2 004 320 255	BS 148	2 007 014 072	BSX 177	3 134 320 341	H 341 / H 111
2 004 320 257	BS 148	2 007 014 073	BSX 163-164	3 134 320 346	H 346
2 004 320 261	BS 129/130	2 007 014 076	BSX 163-164	3 137 014 100	HX 116
2 004 320 263	BS 129/130	2 007 014 077	BSX 170-171	3 137 014 109	HX 116
2 004 320 270	BS 197	2 007 014 079	BSX 172-173	3 137 014 111	HX 346
2 004 320 271	BS 177	2 007 014 080	BSX 178-179	3 137 014 123	HX 124
2 004 320 285	BS 148	2 007 014 081	BSX 180-181	3 137 014 162	HX 161
2 004 320 294	BS 137	2 007 014 082	BSX 177	3 137 014 163	HX 124
2 004 320 295	BS 143	2 007 014 083	BSX 186-187	3 137 014 164	HX 346
2 004 320 296	BS 137	2 007 014 084	BSX 172-173-174	3 137 014 171	HX 155
2 004 320 297	BS 143	2 007 014 085	BSX 170-171	3 137 014 202	HX 172
2 004 320 298	BS 138	2 014 320 001	B 117 / 147 / 188	6 033 AD0 011	BS 192
2 004 320 299	BS 142	2 014 320 003	B 117 / 147 / 188	6 033 AD0 012	BS 193
2 007 014 000	BSX 52	2 014 320 007	B 117 / 147 / 188	6 033 AD0 263	BS 202
2 007 014 001	BSX 12	2 014 320 012	B 117 / 147 / 188	6 033 AD0 264	BS 203
2 007 014 002	BSX 39	2 017 014 100	BX 188	9 001 082 414	BSX 98
2 007 014 004	BSX 148	2 017 014 101	BX 188	9 001 083 592	BSX 592
2 007 014 006	BSX 44 (4)	2 017 014 102	BX 188	9 001 453 644	BSX 177
2 007 014 007	BSX 12	2 017 014 103	BX 188	9 001 454 098	BSX 131 S
2 007 014 008	BSX 148	2 017 014 104	BX 188	9 001 454 104	BSX 131 S
2 007 014 009	BSX 44 (4)	2 017 014 105	BX 188	9 001 454 386	BSX 44 (4)
2 007 014 011	BSX 62	2 104 320 012	B 192	9 001 454 592	BSX 592
2 007 014 012	BSX 67	2 104 320 064	B 192	9 003 334 321	BS 165
2 007 014 013	BSX 35	2 104 320 074	B 104	9 003 334 328	BS 151
2 007 014 014	BSX 186	2 104 320 076	B 140	9 003 334 359	BS 190
2 007 014 015	BSX 148	2 104 320 105	B 68 / 121	9 003 334 360	BS 191
2 007 014 016	BSX 93	2 104 320 107	B 68 / 121	9 003 334 361	BS 194
2 007 014 017	BSX 186	2 104 320 141	BS 12	9 003 334 362	BS 195
2 007 014 018	BSX 70	2 104 320 151	B 135 / 165 / 181	9 003 337 001	BSX 165
2 007 014 019	BSX 102	2 107 014 004	BX 68 (4)	9 104 082 125	BX 169
2 007 014 020	BSX 33	2 107 014 007	BX 140 (4)	9 122 080 043	BX 202
2 007 014 021	BSX 34	2 107 014 012	BX 192 (4)	9 124 080 024	BX 202
2 007 014 022	BSX 85	2 107 014 017	BX 165	9 124 080 043	BX 202
2 007 014 023	BSX 148	2 124 320 003	B 175 / 203	9 124 080 124	BX 202
2 007 014 024	BSX 74	2 124 321 003	B 175 / 203		
2 007 014 026	BSX 75	2 124 321 004	B 184		
2 007 014 027	BSX 75	2 124 321 005	B 175 / 203		
2 007 014 030	BSX 53 / 59 (2)	2 124 321 006	B 206 / 216		
2 007 014 032	BSX 100	2 127 014 003	BX 203	CARGO	
2 007 014 035	BSX 100	2 127 014 004	BX 203	140134	RX 103
2 007 014 036	BSX 148	2 127 014 005	BX 203	140135	RX 106
2 007 014 037	BSX 44 (4)	2 127 014 006	BX 216	140161	LAX 80-81
2 007 014 038	BSX 104 (2)	2 127 014 007	BX 216	140164	H 341 / H 111
2 007 014 040	BSX 139	2 134 20 0563	GS 7	140334	JA-SX 57-58
2 007 014 042	BSX 148	2 134 320 007	GS 11	140336	JA-SX 66-67
2 007 014 044	BSX 96	2 134 320 009	GS 11	140337	JA-SX 94-95
2 007 014 047	BSX 35	2 134 320 015	GS 4	140338	JA-SX 80-81
2 007 014 048	BSX 148	2 134 320 021	B 117 / 147 / 188	140339	JA-SX 56-3/0
2 007 014 049	BSX 100	2 134 320 036	GS 1		

ORIGINAL-REF.	EURO-REF.	ORIGINAL-REF.	EURO-REF.	ORIGINAL-REF.	EURO-REF.
CARGO					
140340	JA-SX 15-6 (4)	140811	RX 120 (2)	BSX 52 4	BSX 52
140341	JA-SX 32-33	140812	RX 120 (4)	BSX 70 4	BSX 70
140342	JA-AX 20 / 29	140813	RX 120/0 (2)	BSX 74 4	BSX 74
140344	JA-AX 12	140814	RX 120/0 (3)	BSX 75 4	BSX 75
140346	JA-SX 47-48	140815	RX 120/0 (4)	BSX 76 4	BSX 76
140347	JA-SX 69-70 (4)	140818	JA-AX 39	BSX 93 4	BSX 93
140348	JA-SX 38	140852	JA-SX 49-61	BSX 96 4	BSX 96
140349	JA-SX 82-83 (4)	140895	LAX 84-85	BSX 97 4	BSX 97
140350	JA-AX 16	140896	LASX 87-77-78	BSX 98 4	BSX 98
140351	JA-AX 25 / 18	140897	LASX 86-79-80	BX 131 2	BX 131
140352	JA-AX 24	140898	LASX 88-77-78	BX 165 2	BX 165
140353	JA-AX 24	140914	JX 43	BX 169 2	BX 169
140354	JA-AX 31	140922	JA-SX 54-55	BX 182 2	BX 182
140356	JA-SX 14 (4)	140930	JAS 43	BX 185 2	BX 185
140357	JA-SX 22 (4)	140931	JAS 46	BX 198 2	BX 198
140359	JA-SX 62	140932	JA-SX 86-87	BX 201 2	BX 201
140360	JA-SX 63	140966	JA-SX 44-28	BX 202 2	BX 202
140361	JA-SX 88	140967	JAS 40	BX 203 2	BX 203
140362	JA-SX 84	140974	IKSX 7	BX 204 2	BX 204
140363	JA-SX 85	141008	BSX 592	BX 206 2	BX 216
140364	JA-SX 77-78	141036	BSX 190-191	BX 209 2	BX 209
140365	JA-AX 9	141070	BSX 172-173-174	BX 210 2	BX 214
140366	JA-AX 5-8	141098	BSX 157-158 K Mercedes	BX 213 2	BX 213
140367	JA-AX 10	ASX 19 4	ASX 19 (4)	BX 215 2	BX 215
140368	JA-AX 28	ASX 7 4	ASX 7	IKSX 2-3	IKSX 2-3
140369	JA-AX 33	BSX 102 4	BSX 102	JSX 13 4	JSX 13 (4)
140370	JA-AX 38	BSX 104 2	BSX 104 (2)	JSX 16 2	JSX 16
140371	JA-AX 35	BSX 106 4	BSX 106	JSX 18 4	JSX 18
140376	JA-SX 56-3	BSX 116 4	BSX 116	JSX 19 4	JSX 19
140378	JA-SX 36-37	BSX 12 4	BSX 12	JSX 21-22	JSX 21-22
140379	JA-SX 74-75	BSX 121F 4	BSX 121	JSX 23-24-28	JSX 23-24-28
140380	JA-AX 32	BSX 124 4	BSX 124	JSX 31-32	JSX 31-32
140385	JA-SX 29	BSX 125 4	BSX 125	JSX 33-34 4	JSX 33-34
140387	JA-SX 98-99	BSX 128 4	BSX 128	JSX 35-36 4	JSX 35-36
140388	JA-SX 71-72	BSX 130 4	BSX 129/130	JSX 35-37 4	JSX 35-37
140393	JA-SX 35	BSX 131 4	BSX 131 S	JSX 38-39-40 3	JSX 38-39-40 (3)
140408	GSX 4	BSX 132 4	BSX 132	JSX 38-41 2	JSX 38-41
140437	JA-AX 34	BSX 134-144 4	BSX 134-144	JSX 5 2	JSX 5
140444	LAX 80-83	BSX 135-145 4	BSX 135-145	JSX 9 4	JSX 9
140465	BSX 44/920	BSX 137-143 4	BSX 137-143	JX 16 2	JX 16
140480	LASX 74-79-80	BSX 138-142 4	BSX 138-142	JX 22 2	JX 22
140481	LASX 77-78-74	BSX 139 4	BSX 139	JX 26 2	JX 26
140509	LASX 92-93	BSX 140 4	BSX 140	JX 28-29 2	JX 28-29
140510	LASX 83-84	BSX 146 4	BSX 146	JX 30-31 2	JX 30-31
140511	LASX 85-84	BSX 147 4	BSX 147	JX 32 2	JX 32
140512	LASX 81-82	BSX 148 4	BSX 148	JX 37-39 2	JX 39-37
140513	LASX 90-91	BSX 149 4	BSX 149	JX 42 2	JX 42
140556	JA-SX 69-70 (3)	BSX 151S 4	BSX 151	LASX 15-16 4	LASX 15-16
140559	JA-SX 40-41	BSX 155 4	BSX 155	LASX 31 4	LASX 31
140567	JA-SX 74	BSX 157-158 4	BSX 157-158 (4)	LASX 36 4	LASX 36
140568	JAS 45	BSX 159-160 4	BSX 159-160 (4)	LASX 37-38-39	LASX 37-38-39
140575	JA-AX 37	BSX 163-164 4	BSX 163-164	LASX 40-41 2P	LASX 40-41
140576	JA-AX 36	BSX 165 4	BSX 165	LASX 42 4	LASX 42
140591	JA-SX 69-70 (4)	BSX 166 4	BSX 166	LASX 43-44 2	LASX 43-44/0 w/o.term.
140595	JA-SX 92-93	BSX 170-171 4	BSX 170-171	LASX 44-45 2P	LASX 44-45
140597	JA-SX 34-30	BSX 172-173 4	BSX 172-173	LASX 5-6 2+1P	LASX 5-6
140598	RX 132-133	BSX 175-176 4	BSX 175-176	LASX 73-41 2+1P	LASX 73-41
140600	RX 457-458	BSX 177 4	BSX 177	LAX 23 2	LAX 23
140602	JA-SX 39	BSX 178-179 4	BSX 178-179	LAX 29 2	LAX 29
140603	LASX 30-31-32	BSX 180-181 4	BSX 180-181	LAX 30 2	LAX 30
140613	LAX 82	BSX 186-187 4	BSX 186-187	LAX 31 2	LAX 31
140647	JA-SX 53	BSX 190-191 4	BSX 190-191	LAX 31-32 2	LAX 31-32
140708	JA-SX 91	BSX 192-193 4	BSX 192-193	LAX 9 2	LAX 9
140716	LASX 15-27	BSX 194-195 4	BSX 194-195	MASX 13-14 4	MASX 13-14
140732	RX 419-420	BSX 196 4	BSX 196	MASX 15-16 4	MASX 15-16
140740	JA-SX 52	BSX 197 4	BSX 197	MASX 17-18 4	MASX 17-18
140755	RX 911 (RX 138)	BSX 34 4	BSX 34	MASX 19-20 4	MASX 19-20
140765	LASX 76 (4)	BSX 35 4	BSX 35	MASX 21-22 4	MASX 21-22
140781	JA-SX 59-60	BSX 43 4	BSX 43 (4)	MASX 23-24 4	MASX 23-24
140785	JA-SX 50-51	BSX 44 4	BSX 44 (4)	MASX 25-26 4	MASX 25-26
140808	PSX 142-143	BSX 49 4	BSX 49	MASX 27-28 4	MASX 27-28

ORIGINAL-REF.	EURO-REF.	ORIGINAL-REF.	EURO-REF.	ORIGINAL-REF.	EURO-REF.
CARGO		DENSO			
NOX 29 2P	NOX 29	21660-0040	JAA 5/8	JHTSX 8 M	JA-SX 15-6 (4)
PLX 10 2	PLX 10	21660-0050	JAA 5/8	JHTSX 9 M	JA-SX 56-3
PSX 106-107 2	PSX 106-107	21660-0060	JAA 5/8	JHTX 10	JA-AX 19
PSX 112 4	PSX 112	21660-0080	JAA 5/8	JHTX 11	JA-AX 19
PSX 115-116 2	PSX 115-116	21660-0100	JAA 5/8	JHTX 18	JA-AX 20 / 29
PSX 119-120 2	PSX 119-120	21660-0130	JAA 9	JHTX 18 M	JA-AX 20 / 29
PSX 122-123-124	PSX 122-123-124	21660-0160	JAA 5/8	JHTX 19	JA-AX 19
PSX 129 2+1P	PSX 129	21660-0170	JAA 5/8	JHTX 20	JA-AX 32
PSX 130 4	PSX 130	21660-0311	JAA 33	JHTX 23	JA-AX 32
PSX 132 4	PSX 132	21660-0320	JAA 10	JHTX 27	JA-AX 37
PSX 133 2	PSX 133 / PSX 131	21660-0330	JAA 28	JHTX 29	JA-AX 39
PSX 136-137 4	PSX 136-137	21660-0370	JAA 38	JHTX 5	JA-AX 19
PSX 138-139 2	PSX 138-139 (2)	21660-0390	JAA 35	JHTX 6	JA-AX 12
PSX 140-141 4	PSX 140-141 (4)	21660-0510	JAA 35	JHTX 7	JA-AX 19
PSX 35-36 2	PSX 35-36	21660-0530	JAA 33	JMTSX 24	JA-SX 29
PSX 64-70 2	PSX 64-70 (2)	28099-3430	JAS 89 flex 22 mm	JMTSX 27	JA-SX 70
PSX 81-82 4	PSX 81-82	28099-3950	JAS 89 flex 22 mm	JMTSX 30	JA-SX 47-48
PSX 83-84 4	PSX 83-84	28099-5450	JAS 39	JMTSX 31	JA-SX 47-48
PSX 88 4	PSX 88	28099-6180	JAS 52	JMTSX 36	JA-SX 69-70 (4)
PX 52-54 2	PX 52-54	28510-0441	JAS 84 flex 33 mm	JMTSX 36 N	JA-SX 69-70 (3)
PX 58 2	PX 58	28510-0460	JAS 89 flex 22 mm	JMTSX 37	JA-SX 47-48
PX 60 2	PX 60	28510-0580	JAS 84 flex 33 mm	JMTSX 48	JA-SX 38
RX 103 4	RX 122H	28510-0590	JAS 84 flex 33 mm	JMTSX 49	JA-SX 82-83 (4)
RX 103E 2	RX 103 E	28510-0660	JAS 89 flex 22 mm	JMTSX 49 N	JA-SX 82-83 (3)
RX 103F 2	RX 103 F	28510-0760	JAS 53	JMTSX 54	JA-SX 69-70 (4)
RX 104 4	RX 122	28510-0830	JAS 84 flex 33 mm	JMTSX 55	JA-SX 98-99 12V
RX 124H 6	RX 124H	28510-5320	JAS 84 flex 33 mm	JMTSX 56	JA-SX 71-72
RX 134 4	RX 134	28510-5350	JAS 84 flex 33 mm	JMTSX 57	JA-SX 96-97 24V
RX 135 4	RX 135	28510-5420	JAS 84 flex 33 mm	JMTSX 58	JA-SX 47-48
RX 87 4	RX 87	28530-0480	JAS 35	JMTSX 59	JA-SX 90
RX 95 4	RX 95	28531-0110	JAS 14	JMTSX 65	JA-SX 71
SVX 7 2	SVX 7 / 9	28531-0300	JAS 22	JMTSX 66	JA-SX 71
USX 50-51 2	USX 50-51 (2)	28531-0350	JAS 62	JMTSX 70	JAS 43
USX 50-51 4	USX 50-51 (4)	28531-0380	JAS 63	JMTSX 71	JAS 41
USX 68 2	USX 68	28531-0450	JAS 84 flex 33 mm	JMTSX 72	JAS 46
USX 73-85 2	USX 73-85	28531-0480	JAS 63	JMTSX 9	JA-SX 29
USX 76-77-78	USX 76-77-78	28531-0490	JAS 63	JMTX 13	JA-AX 15
USX 91-92 2	USX 91-92	28531-0632	JAS 88	JMTX 14	JA-AX 16
USX 93-94 2+1	USX 93-94	28531-0680	JAS 85	JMTX 19	JA-AX 25 / 18
UX 67-68 2	UX 67-68	28531-0720	JAS 89 flex 22 mm	JMTX 20	JA-AX 25 / 18
UX 79-80 2	UX 79-80	28531-0730	JAS 89 flex 22 mm	JMTX 22	JA-AX 24
UX 82-83 2	UX 82-83	28531-0750	JAS 86	JMTX 23	JA-AX 25 / 18
UX 84 2	UX 84	28531-0840	JAS 77	JMTX 25	JA-AX 25 / 18
UX 85 2	UX 85	28531-0946	JAS 84 flex 33 mm	JMTX 32	JA-AX 24
UX 87-88 2	UX 87-88	28531-5050	JAS 39 C	JMTX 33	JA-AX 31
UX 90-91 2	UX 90-91			JMTX 34	JA-AX 31
UX 92 2	UX 92			JMTX 35	JA-AX 34
		F C C		JMTX 38	JA-AX 36
				JMTX 39	JA-AX 31
				JMTX 41	JA-AX 36
				JMTX 42	JA-AX 34
DELCO-REMY/AC DELCO				JNDSX 12	JA-SX 14 (4)
		JHTSX 11	JA-SX 56-3	JNDSX 13	JA-SX 22 (2)
		JHTSX 12 M	JA-SX 31	JNDSX 20	JA-SX 62
		JHTSX 17	JA-SX 57-58	JNDSX 25	JA-SX 63
1 0456 457	R 457	JHTSX 25	JA-SX 92-93 12V	JNDSX 28	JA-SX 35
1 0456 458	R 458	JHTSX 28	JA-SX 66-67	JNDSX 31	JA-SX 88
1 0457 119	R 419	JHTSX 28 N	JA-SX 64-65-67	JNDSX 31 M	JA-SX 88
1 0457 120	R 420	JHTSX 29	JA-SX 94-95 24V	JNDSX 32	JA-SX 84
1 0467 935	R 117	JHTSX 31	JA-SX 80-81	JNDSX 33	JA-SX 84
1 049 524	RX 912 (RX 139)	JHTSX 32	JA-SX 92-93 12V	JNDSX 34	JA-SX 85
1 0495 229	R 132	JHTSX 33	JA-SX 56-3/0	JNDSX 35	JA-SX 77-78
1 852 880	RX 96 (R 120)	JHTSX 34	JA-SX 94-95 24V	JNDSX 36	JA-SX 86-87
1 852 883	RX 122H	JHTSX 36	JA-SX 36-37	JNDSX 37	JA-SX 53
1 852 884	RX 122	JHTSX 37	JA-SX 74-75	JNDSX 39	JA-SX 39
1 852 887	RX 124	JHTSX 38	JA-SX 57-58	JNDSX 39 T	JA-SX 39 C
		JHTSX 39	JA-SX 36-37	JNDSX 41	JA-SX 52
		JHTSX 40	JA-SX 74	JNDSX 8	JA-SX 35
		JHTSX 43	JA-SX 34-30	JNDX 11	JA-AX 9
		JHTSX 44	JA-SX 74-75	JNDX 11 M	JA-AX 9
		JHTSX 47	JA-SX 49-61	JNDX 25	JA-AX 5-8
		JHTSX 7 M	JA-SX 15-6 (4)		

ORIGINAL-REF.	EURO-REF.	ORIGINAL-REF.	EURO-REF.	ORIGINAL-REF.	EURO-REF.
F C C					
JNDX 27	JA-AX 5-8	FE-167	JA-SX 77-78	FI-004	JA-SX 22 (2)
JNDX 28	JA-AX 5-8	FE-303	JA-AX 19	FI-025	JA-SX 88
JNDX 29	JA-AX 10	FE-304	JA-AX 19	FI-027	JA-SX 88
JNDX 30	JA-AX 28	FE-306	JA-AX 19	FI-029	JA-SX 89
JNDX 32	JA-AX 33	FE-310	JA-AX 9	FI-030	JA-SX 88
JNDX 33	JA-AX 38	FE-316	JA-AX 19	FI-035	JA-SX 64-65-67
JNDX 34	JA-AX 35	FE-317	JA-AX 19	FI-040	JA-SX 89
JNDX 34 M	JA-AX 35	FE-318	JA-AX 20 / 29	FI-041	JA-SX 85
JNDX 37	JA-AX 35	FE-319	JA-AX 35	FI-046	JA-SX 36-37
JNDX 38	JA-AX 33	FE-320	JA-AX 35	FI-047	JA-SX 64-65-67
JNDX 8	JA-AX 5-8	FF-105	JA-SX 22 (2)	FI-051	JA-SX 92-93 12V
JNDX 9	JA-AX 5-8	FF-110	JA-SX 57-58	FI-052	JA-SX 92-93 12V
JNKXS 20	RX 419-420	FF-111	JA-SX 57-58	FI-053	JA-SX 74
JNKX 6	JA-AX 19	FF-115	JA-SX 14 (4)	FI-054	JA-SX 74-75
		FF-116	JA-SX 14 (4)	FI-055	JA-SX 74-75
		FF-117	JA-SX 66-67	FI-056	JA-SX 74-75
		FF-118	JA-SX 66-67	FI-061	JA-SX 77-78
		FF-119	JA-SX 64-65-67	FI-064	JA-SX 53
FORD		FF-120	JA-SX 66-67	FI-065	JA-SX 39 C
		FF-121	JA-SX 66-67	FI-080	JA-SX 89
1C3U-11056-AA	F 77	FF-122	JA-SX 66-67	FI-081	JA-SX 89
1C3U-11056-BA	F 76	FF-124	JA-SX 39 C	FI-085	JA-SX 89
F0OU-11055-AA	F 71	FF-125	JA-SX 84	FI-086	JA-SX 52
F0OU-11056-AA	F 70	FF-126	JA-SX 22 (2)	FI-109	JA-SX 15-6 (4)
F3RU-11055-AA	F 72	FF-128	JA-SX 85	FI-110	JA-SX 15-6 (4)
F7RU-11055-AA	F 78 w. bus bar	FF-132	JA-SX 84	FI-116	JA-SX 32-33
F7RU-11056-AB	F 74	FF-133	JA-SX 53	FI-117	JA-SX 32-33
F7RU-11056-CA	F 75	FF-134	JA-SX 85	FI-118	JA-SX 56-3
		FF-135	JA-SX 84	FI-119	JA-SX 56-3
		FF-137	JA-SX 64-65-67	FI-120	JA-SX 31
		FF-138	JA-SX 50-51	FI-125	JA-SX 14 (4)
		FF-139+	JA-SX 50-51	FI-126	JA-SX 31
		FF-140	JA-SX 50-51	FI-130	JA-SX 92-93 12V
		FF-141	JA-SX 50-51	FI-131	JA-SX 92-93 12V
F-141	JA-SX 77-78	FF-144	JA-SX 50-51	FI-133	JA-SX 57-58
F-147	JA-SX 31	FF-145	JA-SX 50-51	FI-134	JA-SX 57-58
FA-101	JA-SX 66-67	FF-146	JA-SX 84	FI-135	JA-SX 56-3
FA-102	JA-SX 66-67	FF-150	JA-SX 66-67	FI-136	JA-SX 56-3
FD-111	JA-SX 14 (4)	FF-151	JA-SX 66-67	FI-147	JA-SX 31
FD-133	JA-SX 22 (2)	FF-152	JA-SX 64-65-67	FI-156	JA-SX 53
FD-138	JA-SX 62	FF-155	JA-SX 84	FI-159	JA-SX 94-95 24V
FD-139	JA-SX 62	FF-156	JA-SX 84	FI-164	JA-SX 31
FD-140	JA-SX 63	FF-157	JA-SX 84	FI-167	JA-SX 64-65-67
FD-151	JA-SX 52	FF-158	JA-SX 39 C	FI-168	JA-SX 66-67
FD-154	JA-SX 84	FF-303	JA-AX 20 / 29	FI-172	JA-SX 92-93 12V
FD-155	JA-SX 89	FF-304	JA-AX 20 / 29	FI-173	JA-SX 92-93 12V
FD-156	JA-SX 88	FF-308	JA-AX 9	FI-174	JA-SX 94-95 24V
FD-157	JA-SX 63	FF-310	JA-AX 32	FI-175	JA-SX 94-95 24V
FD-158	JA-SX 85	FF-313	JA-AX 20 / 29	FI-181	JA-SX 94-95 24V
FD-159	JA-SX 85	FF-314	JA-AX 20 / 29	FI-182	JA-SX 94-95 24V
FD-160	JA-SX 85	FF-315	JA-AX 20 / 29	FI-185	JA-SX 94-95 24V
FD-161	JA-SX 77-78	FF-316	JA-AX 20 / 29	FI-186	JA-SX 94-95 24V
FD-162	JA-SX 53	FF-319	JA-SX 39	FI-189	JA-SX 66-67
FD-163	JA-SX 84	FF-321	JA-AX 35	FI-191	JA-SX 77-78
FD-165	JA-SX 84	FF-322	JA-AX 34	FI-192	JA-SX 66-67
FD-166	JA-SX 77-78	FF-323	JA-AX 20 / 29	FI-193	JA-SX 66-67
FD-167	JA-SX 39 C	FF-325	JA-AX 35	FI-194	JA-SX 80-81
FD-168	JA-SX 77-78	FH-123	JA-SX 88	FI-195	JA-SX 80-81
FD-169	JA-SX 84	FH-125	JA-SX 94-95 24V	FI-196	JA-SX 36-37
FD-170	JA-SX 52	FH-126	JA-SX 94-95 24V	FI-197	JA-SX 36-37
FD-311	JA-AX 9	FH-145	JA-SX 88	FI-198	JA-SX 34-30
FD-312	JA-AX 9	FH-303	JA-AX 12	FI-199	JA-SX 34-30
FD-313	JA-AX 28	FH-304	JA-AX 19	FI-200	JA-SX 74-75
FD-315	JA-AX 33	FH-306	JA-AX 33	FI-304	JA-AX 19
FD-316	JA-AX 35	FH-307	JA-AX 33	FI-306	JA-AX 5-8
FD-317	JA-AX 33	FH-318	JA-AX 9	FI-307	JA-AX 5-8
FD-318	JA-AX 35	FH-323	JA-AX 9	FI-315	JA-AX 12
FD-319	JA-AX 35	FH-324	JA-AX 9	FI-318	JA-AX 5-8
FE-123	JA-SX 84	FI-001	JA-SX 74-75	FI-319	JA-AX 5-8
FE-124	JA-SX 84	FI-002	JA-SX 36-37	FI-320	JA-AX 19
FE-143	JA-SX 88	FI-003	JA-SX 36-37	FI-321	JA-AX 19

ORIGINAL-REF.	EURO-REF.	ORIGINAL-REF.	EURO-REF.	ORIGINAL-REF.	EURO-REF.
FUJI					
FI-322	JA-AX 19	FJ-309	JA-AX 25 / 18	FM-302	JA-AX 16
FI-323	JA-AX 20 / 29	FJ-312	JA-AX 25 / 18	FM-303	JA-AX 15
FI-324	JA-AX 20 / 29	FJ-323	JA-AX 9	FM-304	JA-AX 25 / 18
FI-327	JA-AX 19	FJ-324	JA-AX 24	FM-305	JA-AX 25 / 18
FI-329	JA-AX 19	FJ-325	JA-AX 25 / 18	FM-307	JA-AX 25 / 18
FI-330	JA-AX 19	FJ-333	JA-AX 9	FM-309	JA-AX 25 / 18
FI-331	JA-AX 9	FJ-334	JA-AX 25 / 18	FM-310	JA-AX 16
FI-339	JA-AX 19	FJ-336	JA-AX 24	FM-311	JA-AX 32
FI-340	JA-AX 19	FJ-337	JA-AX 24	FM-312	JA-AX 24
FI-347	JA-AX 19	FJ-342	JA-AX 24	FM-313	JA-AX 9
FI-353	JA-AX 20 / 29	FJ-343	JA-AX 31	FM-314	JA-AX 24
FI-354	JA-AX 20 / 29	FJ-344	JA-AX 24	FM-315	JA-AX 24
FI-355	JA-AX 32	FJ-345	JA-AX 31	FM-316	JA-SX 31
FI-356	JA-AX 32	FJ-346	JA-AX 33	FM-317	JA-AX 9
FI-357	JA-AX 32	FJ-347	JA-AX 34	FM-318	JA-AX 33
FI-358	JA-AX 20 / 29	FJ-350	JA-AX 35	FM-319	JA-AX 34
FI-359	JA-AX 20 / 29	FJ-352	JA-AX 36	FM-320	JA-AX 35
FI-360	JA-AX 20 / 29	FJ-354	JA-AX 34	FM-321	JA-AX 32
FI-361	JA-AX 20 / 29	FJ-358	JA-AX 35	FM-322	JA-AX 32
FI-364	JA-AX 33	FK-107	JA-SX 84	FM-323	JA-AX 32
FI-368	JA-AX 19	FK-108	JA-SX 62	FM-324	JA-AX 36
FI-371	JA-AX 20 / 29	FK-109	JA-SX 84	FM-325	JA-AX 34
FI-372	JA-AX 20 / 29	FK-113	JA-SX 66-67	FM-326	JA-AX 34
FI-373	JA-AX 20 / 29	FK-114	JA-SX 66-67	FM-327	JA-AX 36
FI-374	JA-AX 20 / 29	FK-115	JA-SX 89	FN-001	JA-SX 47-48
FI-376	JA-AX 20 / 29	FK-118	JA-SX 66-67	FN-002	JA-SX 47-48
FI-378	JA-AX 20 / 29	FK-119	JA-SX 66-67	FN-003	JA-SX 34-30
FI-381	JA-AX 32	FK-124	JA-SX 63	FN-004	JA-SX 34-30
FI-384	JA-AX 19	FK-125	JA-SX 85	FN-005	JA-SX 64-65-67
FI-391	JA-AX 32	FK-127	JA-SX 63	FN-006	JA-SX 36-37
FI-393	JA-AX 35	FK-128	JA-SX 89	FN-007	JA-SX 36-37
FI-398	JA-AX 20 / 29	FK-129	JA-SX 86-87	FN-008	JA-SX 50-51
FI-403	JA-AX 33	FK-130	JA-SX 53	FN-009	JA-SX 50-51
FI-404	JA-AX 35	FK-131	JA-SX 39 C	FN-015	JA-SX 66-67
FI-405	JA-AX 39	FK-132	JA-SX 64-65-67	FN-016	JA-SX 66-67
FI-406	JA-AX 20 / 29	FK-139	JA-SX 84	FN-017	JA-SX 38
FI-407	JA-AX 32	FK-140	JA-SX 84	FN-018	JA-SX 36-37
FJ-002	JA-SX 71	FK-301	JA-AX 19	FN-027	JA-SX 70
FJ-005	JA-SX 71	FK-302	JA-AX 19	FN-028	JA-SX 70
FJ-007	JA-SX 85	FK-303	JA-AX 9	FN-029	JA-SX 90
FJ-012	JA-SX 71-72	FK-312	JA-AX 10	FN-030	JA-SX 98-99 12V
FJ-016	JA-SX 88	FK-315	JA-AX 35	FN-031	JA-SX 96-97 24V
FJ-025	JA-SX 96-97 24V	FK-316	JA-AX 35	FN-043	JA-SX 50-51
FJ-026	JA-SX 98-99 12V	FM-101	JA-SX 14 (4)	FN-044	JA-SX 50-51
FJ-029	JA-SX 39 C	FM-102	JA-SX 22 (2)	FN-120	JA-SX 31
FJ-030	JA-SX 98-99 12V	FM-109	JA-SX 29	FN-126	JA-SX 29
FJ-125	JA-SX 35	FM-121	JA-SX 70	FN-127	JA-SX 29
FJ-126	JA-SX 70	FM-123	JA-SX 47-48	FN-140	JA-SX 64-65-67
FJ-138	JA-SX 14 (4)	FM-135	JA-SX 69-70 (4)	FN-158	JA-SX 31
FJ-149	JA-SX 47-48	FM-136	JA-SX 69-70 (4)	FN-163	JA-SX 47-48
FJ-150	JA-SX 69-70 (4)	FM-145	JA-SX 47-48	FN-169	JA-SX 31
FJ-151	JA-SX 69-70 (4)	FM-152	JA-SX 82-83 (4)	FN-302	JA-AX 12
FJ-165	JA-SX 47-48	FM-153	JA-SX 82-83 (4)	FN-305	JA-AX 19
FJ-166	JA-SX 47-48	FM-154	JA-SX 90	FN-312	JA-AX 16
FJ-177	JA-SX 38	FM-159	JA-SX 62	FN-317	JA-AX 19
FJ-178	JA-SX 69-70 (4)	FM-160	JA-SX 98-99 12V	FN-318	JA-AX 25 / 18
FJ-179	JA-SX 47-48	FM-161	JA-SX 71	FN-330	JA-AX 20 / 29
FJ-181	JA-SX 35	FM-162	JA-SX 71	FN-331	JA-AX 20 / 29
FJ-183	JA-SX 82-83 (4)	FM-164	JA-SX 70	FN-333	JA-AX 19
FJ-184	JA-SX 82-83 (4)	FM-166	JA-SX 71	FN-336	JA-AX 16
FJ-185	JA-SX 38	FM-167	JA-SX 77-78	FN-342	JA-AX 20 / 29
FJ-188	JA-SX 90	FM-168	JA-SX 85	FN-343	JA-AX 24
FJ-189	JA-SX 70	FM-169	JA-SX 50-51	FN-344	JA-AX 20 / 29
FJ-190	JA-SX 98-99 12V	FM-170	JA-SX 50-51	FN-346	JA-AX 20 / 29
FJ-191	JA-SX 70	FM-171	JA-SX 85	FN-349	JA-AX 31
FJ-192	JA-SX 96-97 24V	FM-178	JA-SX 71-72	FN-352	JA-AX 24
FJ-193	JA-SX 14 (4)	FM-181	JA-SX 74-75	FN-355	JA-AX 20 / 29
FJ-194	JA-SX 70	FM-182	JA-SX 74-75	FN-356	JA-AX 32
FJ-195	JA-SX 88	FM-183	JA-SX 82-83 (4)	FN-357	JA-AX 20 / 29
FJ-200	JA-SX 70	FM-184	JA-SX 82-83 (4)	FN-359	JA-AX 20 / 29
FJ-307	JA-AX 16	FM-185	JA-SX 39 C	FN-360	JA-AX 20 / 29

ORIGINAL-REF.	EURO-REF.	ORIGINAL-REF.	EURO-REF.	ORIGINAL-REF.	EURO-REF.
FUJI					
FN-361	JA-AX 20 / 29	FW-116	JA-SX 84	2114-02313	JAS 32
FN-362	JA-AX 20 / 29	FW-117	JA-SX 84	2114-04313	JAS 57
FN-368	JA-AX 32	FW-301	JA-AX 20 / 29	2114-05312	JAS 66
FN-372	JA-AX 31	FW-302	JA-AX 20 / 29	2114-06312	JAS 33
FN-373	JA-AX 32	FW-303	JA-AX 9	2114-08312	JAS 58
FN-376	JA-AX 32	FY-105	JA-SX 36-37	2114-08313	JAS 67
FN-377	JA-AX 20 / 29	FY-106	JA-SX 36-37	2114-23124	JAS 50
FN-379	JA-AX 20 / 29	FY-111	JA-SX 66-67	2114-3315	JAS 66
FN-380	JA-AX 20 / 29	FY-112	JA-SX 66-67	2114-43125	JAS 61
FN-382	JA-AX 34	FY-113	JA-SX 80-81	2114-53126	JAS 55
FN-383	JA-AX 36	FY-114	JA-SX 80-81	2114-59002	JAS 80/91
FN-385	JA-AX 32	FY-115	JA-SX 56-3	2114-63121	JAS 50
FN-386	JA-AX 39	FY-116	JA-SX 56-3	2114-63125	JAS 49
FN-389	JA-AX 20 / 29	FY-117	JA-SX 56-3	2114-63126	JAS 54
FN-390	JA-AX 32	FY-119	JA-SX 64-65-67	2114-6313	JAS 67
FN-391	JA-AX 37	FY-120	JA-SX 56-3	2114-69002	JAS 81
FN-393	JA-AX 37	FY-121	JA-SX 56-3/0	2114-73122	JAS 50
FN-394	JA-AX 36	FY-122	JA-SX 56-3/0	2114-73123	JAS 59
FN-395	JA-AX 37	FY-123	JA-SX 92-93	2114-83121	JAS 51
FN-396	JA-AX 37	FY-124	JA-SX 92-93	2114-83122	JAS 50
FN-400	JA-AX 36	FY-125	JA-SX 92-93	2114-83123	JAS 60
FN-402	JA-AX 37	FY-126	JA-SX 92-93	2114-93121	JAS 65
FO-301	JA-AX 20 / 29	FY-127	JA-SX 94-95	2114-93122	JAS 50
FO-302	JA-AX 20 / 29	FY-128	JA-SX 94-95	2120-01311	JAS 56
FR-302	JA-AX 9	FY-129	JA-SX 94-95	2120-01312	JAS 56
FR-303	JA-AX 33	FY-130	JA-SX 94-95	2120-02601	JAS 95
FS-112	JA-SX 14 (4)	FY-138	JA-SX 36-37	2120-04311	JAS 3
FS-116	JA-SX 22 (2)	FY-139	JA-SX 36-37	2120-05312	JAS 3
FS-117	JA-SX 22 (2)	FY-140	JA-SX 84	2120-07311	JAS 3
FS-122	JA-SX 22 (2)	FY-143	JA-SX 36-37	2120-07312	JAS 56/0
FS-125	JA-SX 39 C	FY-148	JA-SX 74-75	2120-09311	JAS 3/0
FS-127	JA-SX 85	FY-149	JA-SX 94-95	2130-01310	JAS 95
FS-301	JA-AX 9	FY-150	JA-SX 94-95	2130-01312	JAS 92
FS-304	JA-AX 9	FY-151	JA-SX 36-37	2130-02312	JAS 92
FS-309	JA-AX 35	FY-153	JA-SX 94-95	2130-03311	JAS 92
FS-310	JA-AX 35	FY-155	JA-SX 84	2130-04311	JAS 92
FT-102	JA-SX 22 (2)	FY-156	JA-SX 84	2130-04312	JAS 93
FT-104	JA-SX 14 (4)	FY-157	JA-SX 77-78	2130-05312	JAS 36
FT-111	JA-SX 35	FY-158	JA-SX 85	2130-06312	JAS 34
FT-114	JA-SX 63	FY-159	JA-SX 88	2130-07311	JAS 93
FT-116	JA-SX 62	FY-302	JA-AX 20 / 29	2130-07312	JAS 75
FT-124	JA-SX 84	FY-303	JA-AX 20 / 29	2130-08311	JAS 37
FT-127	JA-SX 84	FY-304	JA-AX 20 / 29	2130-09311	JAS 30
FT-128	JA-SX 88	FY-305	JA-AX 20 / 29	2130-13111	JAS 74
FT-129	JA-SX 89	FY-306	JA-AX 19	2130-23112	JAS 74
FT-130	JA-SX 85	FY-307	JA-AX 20 / 29	2240-01311	JAS 75
FT-133	JA-SX 77-78	FY-309	JA-AX 20 / 29	2240-01312	JAS 75
FT-138	JA-SX 86-87	FY-313	JA-AX 19	2250-01322	JAS 31
FT-139	JA-SX 84	FY-314	JA-AX 19	2250-01324	JAS 95
FT-140	JA-SX 52	FY-315	JA-AX 20 / 29	2250-02323	JAS 94
FT-142	JA-SX 88	FY-317	JA-AX 9	2250-04322	JAS 95
FT-143	JA-SX 39 C	FY-318	JA-AX 34	2250-05322	JAS 37
FT-147	JA-SX 84	FY-321	JA-AX 32	2250-05323	JAS 37
FT-148	JA-SX 84	FZ-101	JA-SX 22 (2)	L119N-01361	JAA 10
FT-149	JA-SX 84	FZ-104	JA-SX 14 (4)		
FT-150	JA-SX 84	FZ-107	JA-SX 84		
FT-151	JA-SX 84	FZ-108	JA-SX 88		
FT-305	JA-AX 9	FZ-109	JA-SX 63	ISKRA	
FT-313	JA-AX 33	FZ-301	JA-AX 9		
FT-314	JA-AX 38				
FT-315	JA-AX 38			16 770 002	BX 202
FT-316	JA-AX 35			16 770 114	BX 202
FT-317	JA-AX 35	HITACHI		16 770 134	JX 32
FT-318	JA-AX 35			16 770 164	BX 192 (4)
FT-319	JA-AX 33			16 770 188	JX 42
FU-101	JA-SX 88	2108-02305	JAS 15	16 770 206	PX 60
FV-301	JA-AX 20 / 29	2108-02306	JAS 6	16 770 241	IKS 7
FV-302	JA-AX 20 / 29	2108-4305	JAS 15	16 770 376	IKS 10
FW-015	JA-SX 14 (4)	2108-4306	JAS 6	16 770 377	IKS 6
FW-111	JA-SX 94-95 24V	2108-6305	JAS 15	16 905 063	BSX 131 S
FW-112	JA-SX 94-95 24V	2108-6306	JAS 6	16 905 108	IKSX 1

ORIGINAL-REF.	EURO-REF.	ORIGINAL-REF.	EURO-REF.	ORIGINAL-REF.	EURO-REF.
MARELLI / FIAT					
8322 4481	JS 38 / 47	M647C00573	JAS 40	MD611689	JA-AX 36
8322 4621	JS 42	M647C00671	JAS 42	MD611731	JA-SX 42-43
8322 5264	JS 39	M647C00871	JAS 40	MD611918	JA-SX 42-43
8322 5265	JS 40	M647C01771	JAS 42	MD618460	JA-SX 98-99 12V
8322 5266	JS 41	M647X02071	JAS 40	ME021981	JA-AX 9
8322 5822	JS 43 / 50	M647X02671	JAS 40	ME700047	JA-SX 71-72
8322 5823	JS 45	M647X03471	JA-SX 44-28	ME700127	JA-SX 98-99 12V
8322 5824	JS 44 / 48	M647X04571	JA-SX 44-28	ME700140	JA-SX 96-97 24V
8322 6148	JS 46	M647X05571	JA-SX 44-28	ME700290	JA-SX 71-72
8322 6189	JS 38 / 47	M647X05871	JA-SX 44-28	ME700424	JA-AX 31
8322 6217	JS 44 / 48	M648C10171	JAS 29	ME700858	JA-SX 71
8322 6218	JS 49	M648C10371B	JAS 70	ME700939	JA-SX 71-72
8322 6428	JS 43 / 50	M648C10671	JAS 29	ME701169	JA-SX 96-97 24V
8322 6919	JS 53	M648C12170	JAS 69	ME701186	JA-AX 31
8322 6920	JS 54	M648C12370	JAS 69	ME701188	JA-SX 98-99 12V
8322 6921	JS 58	M648C13770	JAS 70	ME702997	JA-AX 33
8322 7258	JS 33	M648C14870	JAS 83	MF022002	JA-SX 35
8322 7362	JS 51 / 62	M648C14871	JAS 83	MM502019	JA-SX 47-48
8322 7364	JS 52 / 61	M648C14970	JAS 82	MM502135	JA-SX 47-48
8322 7470	JS 59	M648C14971	JAS 82	MM502344	JA-SX 70
8322 7490	JS 40	M648C15070	JAS 83	MM502377	JA-AX 31
8322 7491	JS 39	M648C15372	JAS 98		
8322 7493	JS 56	M648C15472	JAS 99		
8322 7494	JS 55 / 57	M648C16471	JAS 46		
8322 7495	JS 55 / 57	M648C20371	JAS 47	VALEO	
8322 7583	JS 51 / 62	M648C22371	JAS 47		
8322 7584	JS 52 / 61	M648C24471	JAS 48		
8322 7657	JS 63	M648C24472	JAS 48	073 742	PX 50
8322 8257	JS 34	M648C25271	JAS 38	075 411	PX 52-54
85 3160	JS 9/14	M648C25273	JAS 38	092 672	PX 56
901 0905	MAS 3	M648C25671	JAS 71	092 743	PX 56
991 1443	BS 36 / MAS 4	M648C25672	JAS 72	092 746	PX 56
992 7791	MAS 13	M648C26371	JA-SX 96-97 24V	092 850	PX 56
992 7792	MAS 14	M648C31171	JAS 41	092 859	SVX 7 / 9
992 8448	MAS 16	M648C32971	JAS 43	092 967	SVX 7 / 9
992 9080	MAS 15	M648D20671	JAS 48	095 788	PX 52-54
993 5196	MAS 17	M648D20771	JAS 48	095 984	PX 52-54
993 5197	MAS 18	M648X28271	JA-SX 98-99 12V	096 026	PX 52-54
995 6552	MAS 18	M648X28671	JA-SX 96-97 24V	096 302	PX 56
995 6556	MAS 17	M649T04372	JA-SX 90	096 304	PX 52-54
		MD602018	JA-AX 25 / 18	096 322	PX 52-54
		MD602019	JA-AX 25 / 18	096 334	PX 52-54
		MD602069	JA-SX 70	098 627	PX 57
		MD602226	JA-AX 25 / 18	098 689	PX 57
		MD602458	JA-AX 16	182 037	PSX 152-153
		MD602468	JA-SX 69-70 (4)	182 051	PSX 138-139 (2)
		MD602470	JA-SX 69-70 (4)	182 054	PSX 140-141 (4)
A647X00771	JAA 24	MD602750	JA-AX 25 / 18	182 064	PSX 115-116
A647X10771	JAA 24	MD602783	JA-AX 24	182 065	PSX 129
A648C00570	JAA 16	MD602797	JA-AX 25 / 18	182 066	PSX 133 / PSX 131
A648C01371	JAA 15	MD604018	JA-AX 9	182 067	PSX 133 / PSX 131
A648C02970	JAA 34	MD604067	JA-SX 14 (4)	182 068	PSX 130
A648D01070	JAA 25	MD604240	JA-SX 22 (4)	182 069	PSX 55-76
A648D01071	JAA 24	MD604256	JA-SX 35	182 070	PSX 119-120
A648D01670	JAA 24	MD604474	JA-SX 35	182 071	PSX 115-116
A648D01671	JAA 24	MD604643	JA-SX 39	182 072	PSX 106-107
A648D01970	JAA 31	MD604916	JA-SX 85	182 073	PSX 122-123-124
A648D01971	JAA 31	MD607373	JA-AX 24	182 097	PSX 64-70 (2)
A648D02070	JAA 24	MD607389	JA-SX 69-70 (4)	182 098	PSX 64-70 (4)
A648D02271	JAA 24	MD607420	JA-SX 69-70 (4)	182 099	PSX 115-116-121
A648D02570	JAA 34	MD607461	JA-SX 90	182 101	PSX 127
A648D02571	JAA 34	MD607554	JA-SX 82-83 (4)	182 112	PSX 115-116-121
A648D02770	JAA 36	MD607556	JA-SX 82-83 (4)	182 113	PSX 115-116-121
A648D03070	JAA 36	MD607897	JA-SX 45-46	182 114	PSX 81-82
A649T02971	JAA 25	MD607899	JA-SX 45-46	182 115	PSX 96-97
A649X04070	JAA 24	MD607949	JA-SX 70	182 116	PSX 115-116
A990D03070	JAA 36	MD611024	JA-SX 71	182 117	PSX 125
M647C00171	JAS 45	MD611035	JA-AX 34	182 118	PSX 132
M647C00271	JAS 40	MD611216	JA-SX 40-41	182 132	PSX 83-84
M647C00272	JAS 40	MD611217	JA-SX 40-41	182 133	PSX 115-116-121
M647C00371	JAS 42	MD611566	JA-AX 34	182 134	PSX 83-84
M647C00571	JAS 40				

ORIGINAL-REF.	EURO-REF.	ORIGINAL-REF.	EURO-REF.	ORIGINAL-REF.	EURO-REF.
VALEO					
182 135	PSX 115-116-121	72 622	PSX 37-58		
182 145	PSX 83-84	72 625	PSX 115-116-121		
182 146	PSX 112	72 628	PSX 115-116-121		
182 162	PSX 88	72 629	PSX 115-116-121		
182 194	USX 44-21	72 630	PSX 83-84		
182 231	PX 50	72 631	PSX 81-82		
20 856	USX 73-85	72 632	PSX 115-116-121		
20 947	UX 67-68	72 734	PSX 115-116		
21 177	UX 67-68	73 608	PSX 119-120		
23 268	UX 71-72	73 742	PX 50		
300 665	PX 58	73 829	PSX 115-116		
300 679	PSX 81-82	75 093	PSX 96-97		
300 682	PX 58	75 217	USX 44-21		
300 686	PX 56	75 226	USX 45-23		
300 687	PSX 130	75 238	USX 60-59		
300 700	PSX 115-116-121	75 411	PX 52-54		
300 706	PSX 133 / PSX 131	75 452	PSX 64-70 (4)		
300 722	PX 60	75 707	PSX 132		
300 796	SVX 7 / 9	78 166	PSX 106-107		
300 821	SVX 7 / 9	78 865	PSX 83-84		
300 841	PSX 136-137	78 900	PSX 112		
300 842	PSX 136-137	79 325	USX 50-51 (2)		
300 875	PX 57	79 353	UX 67-68		
581 068	UX 85	92 433	PSX 119-120		
581 092	UX 84	92 435	PSX 115-116		
581 111	UX 87-88	92 655	PSX 115-116		
581 118	UX 87-89	92 656	PSX 119-120		
581 133	UX 87-88	92 669	PX 56		
581 144	UX 90-91	92 694	PSX 115-116-121		
581 154	UX 90	92 695	PSX 115-116-121		
581 159	UX 92	92 744	PSX 125		
581 161	UX 93	92 765	PSX 122-123-124		
581 164	UX 94	92 824	PSX 127		
581 216	UX 95	92 878	PSX 129		
581 222	UX 96	92 883	PSX 130		
583 041	USX 91-92	92 914	PSX 133 / PSX 131		
583 241	USX 93-94	92 925	PSX 132		
583 320	USX 93-94	98 627	PX 57		
594 060	PSX 148-149/0	98 689			
594 062	PSX 148-149/0				
594 063	PSX 148-149/0				
594 064	PSX 146-147/0				
594 065	PSX 129				
594 066	PSX 133 / PSX 131				
60 556	USX 50-51 (2)				
60 567	USX 50-51 (4)				
606 384	USX 73-85				
607 084	USX 76-77-78				
608 267	UX 79-80				
608 272	UX 79-80				
609 592	USX 73-85				
609 778	USX 73-85				
618 306	UX 82-83				
618 481	USX 60-59				
618 491	USX 73-85				
618 509	USX 50-51 (4)				
618 539	USX 76-77-78				
618 570	USX 60-59				
618691,692	USX 91-92				
72 591	PSX 64-70 (2)				
72 592	PSX 115-116				
72 593	PSX 37-58				
72 595	PSX 55-76				
72 596	PSX 115-116-121				
72 615	PSX 88				
72 616	PSX 55-76				
72 617	PSX 115-116				
72 618	PSX 119-120				
72 619	PSX 115-116				
72 620	PSX 37-58				
72 621	PSX 35-36				